

legris transair

> Advanced air pipe systems



Transair[®]

> System benefits

COMPLETELY ADAPTABLE

- > Removeable and reusable components



EASIER

HANDLING

Pipe and fittings are supplied ready for immediate installation
> NO PREPARATION REQUIRED

Quick assembly - no need to weld, solder, glue, crimp or thread
> TIME SAVING

- > EASY TO ASSEMBLE



Lightweight, easy to cut pipe material

- > EASIER WORKING ON SITE

Immediate Start-up
> SYSTEM QUICKLY READY FOR TEST AND USE

ENERGY SAVINGS

Consistent high quality internal surface
> CLEAN AIR

Full flow connection and low friction internal surface of the pipe
> HIGH FLOW RATE PERFORMANCE

- Calibrated pipe diameter
> OPTIMUM SEALING

HIGH RESISTANCE TO

- > corrosion
- > aggressive environments
- > mechanical shocks
- > thermal variations
- > Ultraviolet (U.V.)
- > compressor oil carry over (mineral or synthetic)

**COMPONENTS
GUARANTEED
FOR
2 YEARS**

SAFETY

- > non-flammable materials
- > Conform to UL 94HB and UL94V-2

Legris has a policy of continual product development and, therefore, reserves the right to modify any products shown in this catalog, without notification. All dimensions are indicative.

> Contents



> Introduction

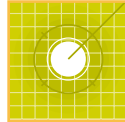

Technical specifications	02
Sizing	03
Flow rates and pressure drop	04
Transair Flow Calculator	05
Safety	06
Certification and Guarantee	07
Material	08
Transair Technology	09
Services	10

> Products catalog



Rigid aluminum pipe	14
Flexible hose	15
Pipe-to-pipe and threaded connectors	16
Quick assembly brackets	22
Wall brackets	25
Ball valves and butterfly valves	26
Tools	28
Fixture accessories	32
Hose reels - blowgun	34
Automatic couplers	35

> Installation guide



Essential instructions	40
Aluminum pipe	42
Pipe-to-pipe connectors	48
Quick assembly brackets	59
Flexible hose	65
Fixture accessories	70
Practical information	74
Transair in use	81

> Index



Part numbers Index	86
Addresses	87

> Technical specifications

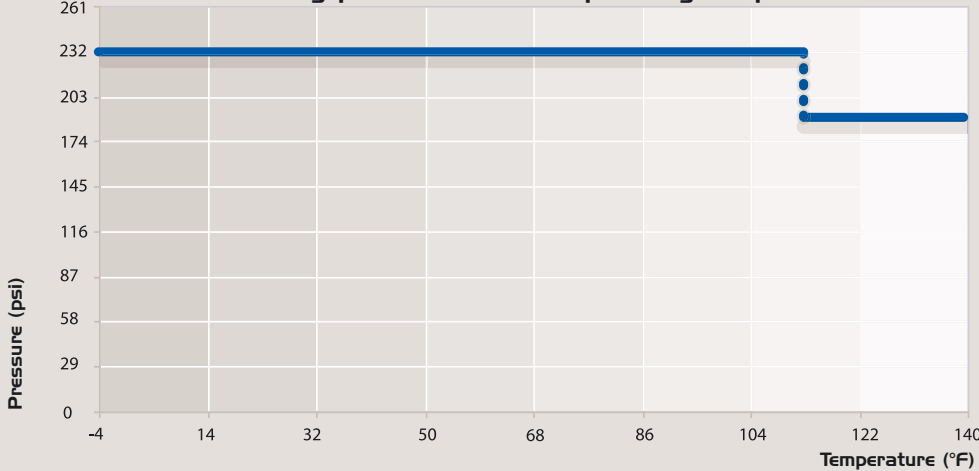
<p>> Fluids</p>	<ul style="list-style-type: none"> • Compressed air (dry, wet, lubricated) • Vacuum • Inert gases • Other fluids: please consult us 										
<p>> Maximum working pressure</p>	<p>188 psi from -4°F to +140°F 232 psi from -4°F to +115°F</p>										
<p style="text-align: center;">Maximum working pressure versus operating temperature</p>  <table border="1" style="display: none;"> <caption>Data points for Maximum working pressure versus operating temperature</caption> <thead> <tr> <th>Temperature (°F)</th> <th>Pressure (psi)</th> </tr> </thead> <tbody> <tr> <td>-4</td> <td>232</td> </tr> <tr> <td>115</td> <td>232</td> </tr> <tr> <td>115</td> <td>188</td> </tr> <tr> <td>140</td> <td>188</td> </tr> </tbody> </table>		Temperature (°F)	Pressure (psi)	-4	232	115	232	115	188	140	188
Temperature (°F)	Pressure (psi)										
-4	232										
115	232										
115	188										
140	188										
<p>> Vacuum level</p>	<p>98.7 % (29.6" Hg)</p>										
<p>> Working temperature</p>	<p>from -4°F to +140°F</p>										
<p>> Storage temperature</p>	<p>from -40°F to +176°F</p>										
<p>> Resistance to</p>	<ul style="list-style-type: none"> • corrosion • aggressive environments • mechanical shocks • thermal variations • U.V. • mineral compressor oils • synthetic compressor oils • compressor oil carry over 										

<p>> Environment</p>	<p>Materials are 100% recyclable. Transair pipe, fittings and valves are guaranteed silicone free.</p>
-------------------------	--

> Sizing

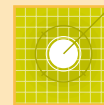

Select the Transair diameter for your application based on required flow against pressure drop.
Estimated values for: a closed loop network, a pressure of 115 psi with 5% pressure drop.

Flow rate			Length										Compressor (hp)
			164ft	328ft	492ft	984ft	1640ft	2460ft	3280ft	4265ft	5249ft	6561ft	
Nm ³ /h	NI/min	cfm	50m	100m	150m	300m	500m	750m	1000m	1300m	1600m	2000m	
10	167	6	16,5	16,5	16,5	16,5	16,5	16,5	16,5	25	25	25	2 - 10
30	500	18	16,5	16,5	16,5	25	25	25	25	25	25	40	
50	833	29	16,5	25	25	25	25	25	40	40	40	40	
70	1167	41	25	25	25	25	40	40	40	40	40	40	10 - 40
100	1667	59	25	25	25	40	40	40	40	40	40	63	
150	2500	88	25	40	40	40	40	40	40	63	63	63	
250	4167	147	40	40	40	40	63	63	63	63	63	63	40 - 100
350	5833	206	40	40	40	63	63	63	63	63	63	76	
500	8333	294	40	40	63	63	63	63	63	76	76	76	
750	12500	441	40	63	63	63	63	76	76	76	76	100	100 - 425
1000	16667	589	63	63	63	63	63	76	76	100	100	100	
1250	20833	736	63	63	63	63	63	100	100	100	100	100	
1500	25000	883	63	63	63	76	76	100	100	100	100	100*	100 - 425
1750	29167	1030	63	63	76	76	76	100	100	100	100*	100*	
2000	33333	1177	63	76	76	76	100	100	100	100*	100*	100*	
2500	41667	1471	63	76	76	76	100	100*	100*	100*	100*	100*	> 425
3000	50000	1766	76	76	76	100	100	100*	100*	100*	100*	100*	
3500	58333	2060	76	76	100	100	100*	100*	100*	100*	100*	100*	
4000	66667	2354	76	100	100	100	100*	100*	100*	100*	100*	100*	> 425
4500	75000	2649	76	100	100	100*	100*	100*	100*	100*	100*	100*	
5000	83333	2943	76	100	100	100*	100*	100*	100*	100*	100*	100*	
5500	91667	3237	100	100	100	100*	100*	100*	100*	100*	100*	100*	> 425
6000	100000	3531	100	100	100*	100*	100*	100*	100*	100*	100*	100*	

*Pressure drop >5%

> Example

- Main network length (ring main): 984 ft
 - Compressor power: 40 hp
 - Required flow rate: 147 cfm
 - Working pressure: 115 psi
-
- The most suitable Transair diameter is: Ø 40.

To size your air pipework system, you can also use the Transair Flow Calculator.
 For more information, refer to page 5 of this catalog.

> Flow rates and pressure drop

Measurements provided by the official French testing body CETIM - Centre Technique des Industries Mecaniques. Charts are based on a 100 feet straight Transair line.

Maximum flow rate with 5% pressure drop (To convert to cfm, use a coefficient of 0.588.)

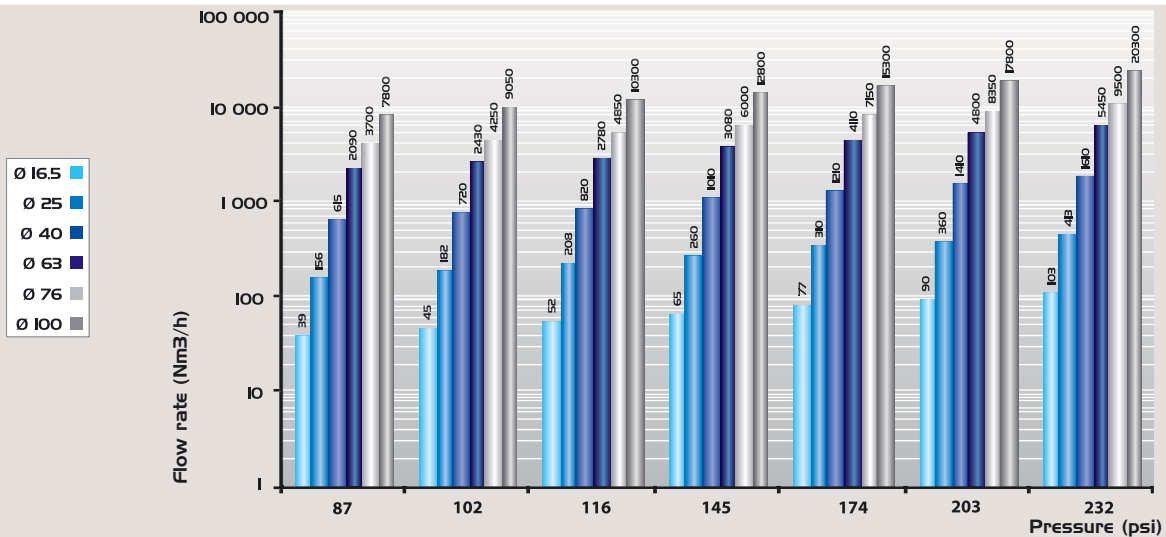

Maximum flow rate with 1.45 psi pressure drop. (To convert to cfm, use a coefficient of 0.588.)

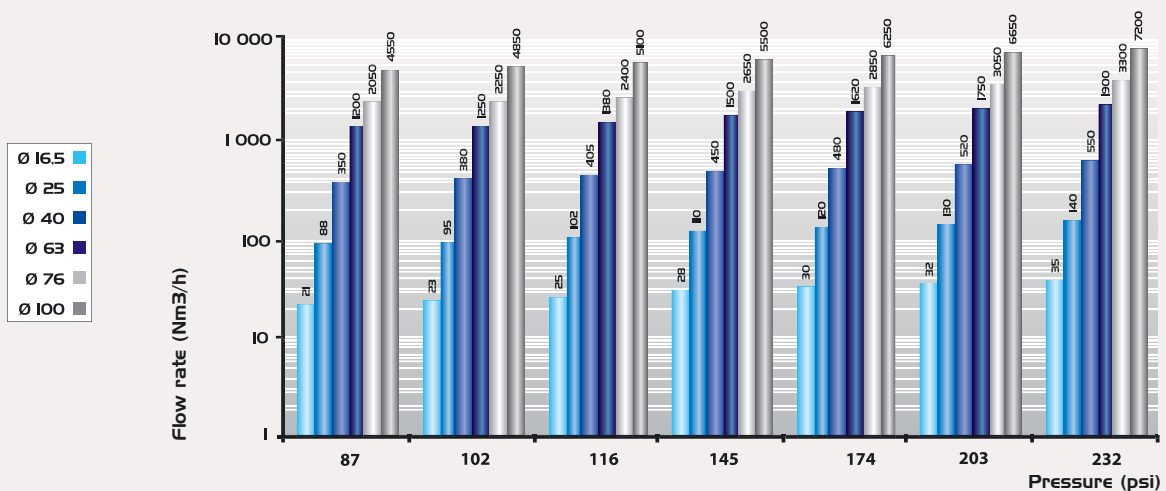

> Transair Flow Calculator



The Transair Flow Calculator helps you to choose the most suitable diameter for your installation. Enter the flow of your compressor, the system pressure rating and the total equivalent length of the system. Select ring main or straight line layout, enter your preferred unit of calculation and then click for an immediate indication of the most suitable Transair diameter (with a pressure drop of less than 5%).

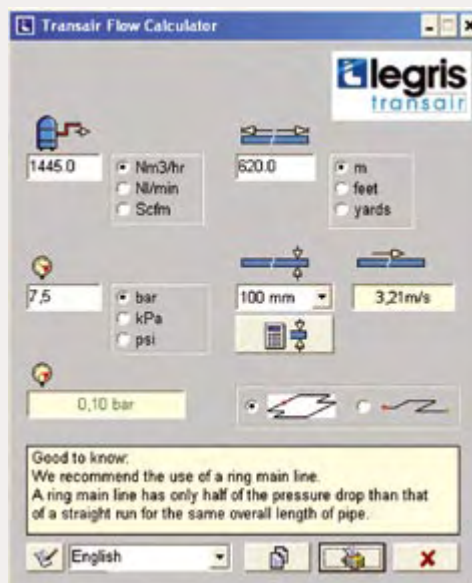

>Example

- > Flow rate: 850 cfm at 109 psi
- > Ring main: 1788 feet
- > The recommended Transair diameter is \varnothing 100mm
(pressure drop of 145 psi = less than 5 %)

>Download

The new Transair Flow Calculator from our web site:
www.transair-usa.com

> Safety

> Fire resistance

All Transair components are non-flammable with no propagation of flame.

- pipe-to-pipe and male connectors, ball valves and butterfly valves: conform to UL94HB standard
- fixture clips: conform to UL94V-2 standard
- flexible hoses: conform to ISO 8030 norm for compressed air applications, and to EN 12115 norm for vacuum applications
- pipe powder coat finish classified M0

> Electrical conductivity

In areas of potential risk, the earthing and electrical continuity of metallic components are obligatory. The Transair system can be used in such environments by undertaking the appropriate precautions. For more information, please consult us.

> CE conformity

Transair conforms to European standard 97/23 CEE - §3.3 (equipment under pressure).



DECLARATION OF CE CONFORMITY Supplied in conformity with the **DIRECTIVE on EQUIPMENT UNDER PRESSURE** **97/23/CEE**

We hereby declare that all Transair connectors manufactured by LEGRIS S.A. should be considered as piping components which designed according to sound working practice. "Piping includes in particular a pipe or system of pipes, tubing, fittings, expansion joints, hoses, or other pressure-bearing components as appropriate" – cf acceptance by the «pressure working group» dated 28/01/1999 and by the GTP Commission dated 27/11/1998.

Products designed according to the code of practice.

Product description: Transair connectors \emptyset 16.5 - \emptyset 25 - \emptyset 40 - \emptyset 63 - \emptyset 76 - \emptyset 100

Applicable approvals: AFAQ Certificate of Approval, EN ISO 9001

> Certification and Guarantee

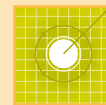

> Certification ISO 9001 version 2000



Legris S.A. is certified ISO 9001 version 2000 and operates a Quality Management System in order to ensure the level of quality and service that is expected by its customers.

> TÜV certification



A product certified TÜV is a pledge of safety and quality. The Group TÜV thus certifies independent test results – in particular, the properties of the products and the standards whereby they were examined.

> QUALICOAT certification



QUALICOAT certification is a guarantee of the quality of the lacquer finish applied to Transair aluminum pipe.

> ASME B31.1 > ASME B31.3



Transair meets the requirement of ASME B31.1 and B31.3. - which stipulates "the minimum requirements for the design, materials, fabrication, erection, test and inspection of power and auxiliary piping systems for industrial institutional plants".

All TRANSAIR components are guaranteed for 2 years.



- TRANSAIR GUARANTEE -

Legris SA agrees to replace free of charge any Transair component which does not function due to a manufacturing or material defect, within a period of 2 years from the date of the installation.

The present guarantee is valid on condition that:

- Legris SA is given reasonable access to examine the products at issue.
- A material or an assembly defect in the fitting or other Transair component must be clearly and obviously identified.

Excluded from this guarantee, which is limited to the cost of product replacement, are defects outside the control of Legris SA, in particular:

- Defects resulting from shocks, vibrations or wear due to contact with any element external to the Transair® installation.
- Defects due to installation not complying with Legris SA's guidelines and recommendations.
- Defects due to an installation being used outside the technical limits defined by Legris SA.
- Defects caused by product modifications not approved in advance by Legris SA.

Claims under this Guarantee should be addressed in writing simultaneously to the distributor of the Transair® products concerned and to Legris SA, 74, rue de Paris, BP 70411 -35704 Rennes Cedex7 France, and its subsidiary

Site owner

Exact address

Number

Street Town / City

Post Code

Country

Building type: New Extension

> Material

	Ø 16.5 - Ø 25 - Ø 40	Ø 63		Ø 76 - Ø 100
1013A	powder coated aluminum	powder coated aluminum	TA16	powder coated aluminum
1016A	powder coated aluminum	powder coated aluminum	TA16	powder coated aluminum
1001E air	hose and coating: black SBR reinforcement: synthetic braiding	hose and coating: black SBR reinforcement: synthetic braiding	EW05	seal: EPDM
1001E vacuum	hose and coating: black SBR / NBR reinforcement: spiral steel wire	hose and coating: black SBR / NBR reinforcement: spiral steel wire	FP01	hose and connector: black SBR/NBR reinforcement: spiral steel wire
4002	polyamide with fiberglass	body: polyamide with fiberglass nut: treated aluminum	RP01	body and pushing ring: polyamide with fiberglass - seal: NBR
4088 - 4099	body: treated brass nut: engineering grade plastic	-	RR01	clamp: treated steel cartridge: polyamide with fiberglass seal: NBR
Anti whip-lash strap	Steel			
6602 - 6604	polyamide with fiberglass	treated aluminum	RR61	
6605	body: treated brassnut: polymer HR / NBR	body: treated brass nut: treated aluminum / NBR	RX02	stainless steel 304
6606	polyamide with fiberglass	treated aluminum	RX12	stainless steel 304
6612	polyamide with fiberglass	treated aluminum	RX04	stainless steel 304
6621	treated aluminum	-	RX23	stainless steel 304
6625	polyamide with fiberglass	treated aluminum	RX24	stainless steel 304
6651	body: treated brass nut: polyamide with fiberglass	-	RX64	stainless steel 304
6663	body: polyamide with fiberglass insert: brass	body: polyamide with fiberglass insert: brass	RX66	stainless steel 304
6662	polyamide with fiberglass	polymère HR	RX30	stainless steel 304
6666	body: treated aluminum nut: polyamide with fiberglass	treated aluminum	VR02	body: iron disc and shaft: stainless steel
6676	polyamide with fiberglass	body: treated aluminum nut: polymer HR	VR03	nickel-plated brass
6683 - 6684	body: treated brass nut: polyamide with fiberglass	-	Bracket	zinc steel - rubber EPDM
6687 - 6688	treated brass	-	All Transair pipe, fittings and valves are guaranteed silicone free.	
EA98	body: treated iron ball valve: plated brass	-		
RA69	polyamide with fiberglass	-		
RA65	body: polyamide with fiberglass insert: brass	-		
Clip - Spacer	polyamide with fiberglass	polyamide with fiberglass		
0169 Adaptor	brass	-		
Composite coupler	body: polymer HR / Zamac - sleeve: polymer HR - spring and ball bearings: stainless steel - seal: nitrile - probe: treated steel			
Hose reel	metal case - fixing: metal			
Blowgun	reinforced polyamide - treated aluminum - insert brass			

> Transair Technology



The innovative technology of Transair enables rapid and easy assembly: quick connection of components to the aluminum pipe. This technology takes into account the specific requirements of each diameter and provides the user with an optimum safety coefficient and easy connection.

- > Ø 16.5 (1/2")
- > Ø 25 (7/8")
- > Ø 40 (1 1/2")

Pipe-to-pipe and male connectors in Ø 16.5, Ø 25 and Ø 40 can be immediately connected to Transair pipe - simply push the pipe into the connector up to the connection mark. The gripping ring of each fitting is then automatically secured and the connection is safe.



- > Ø 63 (2 1/2")

Pipe-to-pipe and male connectors in Ø 63 can be quickly connected to Transair aluminum pipe by means of a double clamp ring. This secures the connection between the nut and the pipe - tightening of the nuts secures the final assembly.

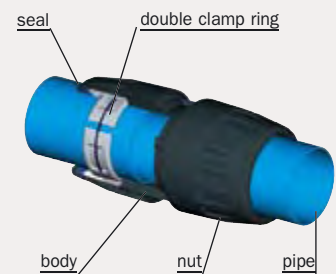

- > Ø 76 (3")
- > Ø 100 (4")

Pipe-to-pipe and male connectors in Ø 76 and Ø 100 can be quickly connected to Transair aluminum pipe. Position the pipes to be connected within the Transair cartridge and close/tighten the Transair clamp.

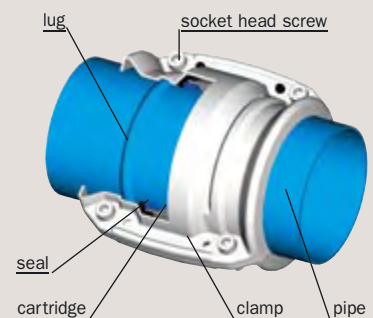

> Services

A number of additional Transair services help you throughout your projects.

> Project assistance



Understanding, Proximity, Responsiveness. Field support

Transair technical teams are at your disposal to study and help design your air network. In particular, they assist you in your project with:

- Information on the Transair products and services,
- Guidance and training on how to assemble the system,
- Advice on “best practice” in order to reduce your consumption of energy,
- Ongoing assistance and follow-up.
- On-site advisory presence at construction and installation locations.

Internally

Our CUSTOMER SERVICE teams will co-ordinate a quick response to your requirements.

> Customer service

- Product availability
- Order processing and follow-up
- Delivery time-phasing and modification
- Technical information

> Costing service

- Advice
- Design software

> Wherever you are in the world, you can contact us:

- by phone
 - by fax
 - by mail
 - by e-mail
- 7205 E. Hampton Ave.
Mesa, AZ 85209
Ph. (480) 830-7764 Fax (480) 325-3571
www.transair-usa.com

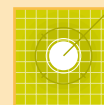

> Transair design software

- Installation sizing
- System layout and drawing
- Shopping list
- Available on CD

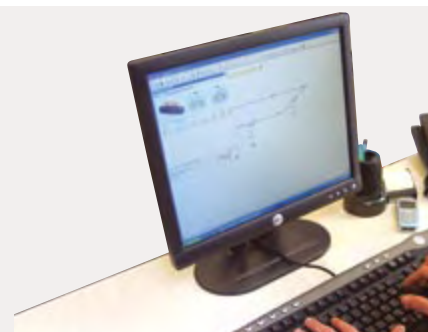

> Web site

- Practical information
- Downloadable literature files: catalogs, information on new products, introductory flyers, instruction guidelines, newsletter

www.transair-usa.com



> CAD drawings

All Transair CAD drawings are available on a CD - in DWG format.

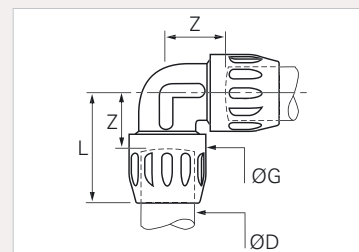

> Specification sheets

Formal technical specifications for the Transair system are available in either Word or PDF format and can be directly integrated into your own documents.

ENERGY
SAVINGS

Consistent high quality
internal surface
> CLEAN AIR

Full flow connection and low friction
internal surface of the pipe
> HIGH FLOW RATE PERFORMANCE

Calibrated pipe diameter
> OPTIMUM SEALING

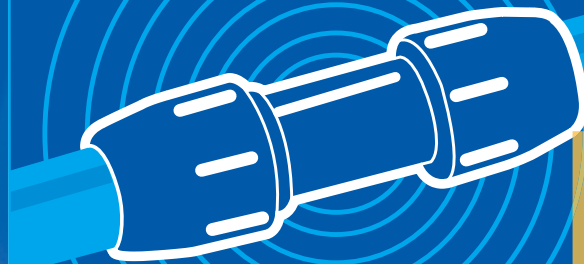







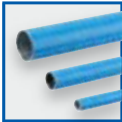
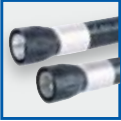

**COMPONENTS
GUARANTEED
FOR
2 YEARS**

SAFETY

> non-flammable
materials

> Products catalog

	Rigid aluminum pipe	14
	Flexible hose	15
	Pipe-to-pipe and threaded connectors	16
	Quick assembly brackets	22
	Wall brackets	25
	Ball valves and butterfly valves	26
	Tools	28
	Fixture accessories	32
	Hose reels - blowgun	34
	Automatic couplers	35

> Rigid aluminum pipe

- > Clean air
- > Optimum flow rate performance
- > Lightweight
- > QUALICOAT certified surface finish
- > Two colors: blue (RAL 5012/BS1710), grey (RAL 7001) (other colors: please consult us)
- > Suitable fluids: compressed air, vacuum, nitrogen, argon (other fluids: please consult us)
- > Ø 76 and Ø 100 pipe is also available in stainless steel (please ask for details)

- > Max. working pressure:
 - 188 psi from -4 °F to +140 °F
 - 232 psi from -4 °F to +115 °F
 (please consult us for higher temperature requirements)
- > Vacuum: 98.7% (29.6" Hg)
- > Working temperature: -4 °F to +140 °F
- > Extruded pipe (conforms to EN 755.2, EN 755.8 and EN 573.3 standards)

Blue pipe

Transair	ØOD (mm)	ØOD (in)	LI (ft)	L (ft)
1013A17 04 00	16.5	1/2	10	9' 9 1/4"
1013A25 04 00	25	7/8	10	9' 7 7/8"
1016A25 04 00	25	7/8	20	19' 9 3/4"
1016A40 04 00	40	1 1/2	20	19' 8 1/4"
1013A40 04 00	40	1 1/2	10	19' 8 1/4"

Grey pipe

Transair	ØOD (mm)	ØOD (in)	LI (ft)	L (ft)
1003A17 06 00	16.5	1/2	10	9' 9 1/4"
1006A25 06 00	25	7/8	20	19' 9 3/4"
1006A40 06 00	40	1 1/2	20	19' 8 1/4"

Blue pipe

Transair	ØOD (mm)	ØOD (in)	LI (ft)	L (ft)
1016A63 04	63	2 1/2	20	19' 7 1/8"
1013A63 04	63	2 1/2	10	19' 7 1/8"

Grey pipe

Transair	ØOD (mm)	ØOD (in)	LI (ft)	L (ft)
1006A63 06	63	2 1/2	20	19' 7 1/8"

Blue pipe

Transair	ØOD (mm)	ØOD (in)	L (ft)
TA16 L1 04	76.3	3	20
TA16 L3 04	101.8	3	20

Grey pipe

Transair	ØOD (mm)	ØOD (in)	L (ft)
TA06 L1 06	76.3	3	20
TA06 L3 06	101.8	4	20

Pipe sizes:

- 16.5 mm O.D. = 1/2" ID
- 25 mm O.D. = 7/8" ID
- 40 mm O.D. = 1 1/2" ID
- 63 mm O.D. = 2 1/2" ID
- 76.2 mm O.D. = 3" ID
- 101.6 mm O.D. = 4" ID

Ø
16.5
25
40

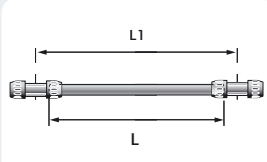
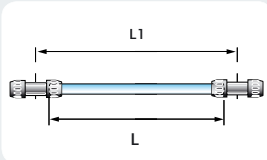
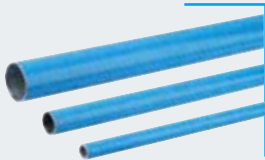

Ø
63

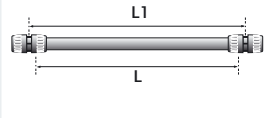
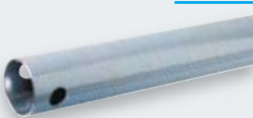
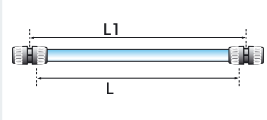
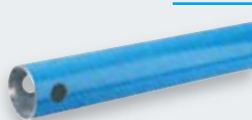

Ø
76
100

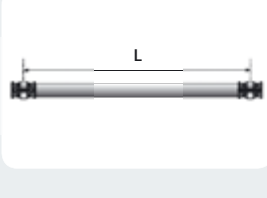
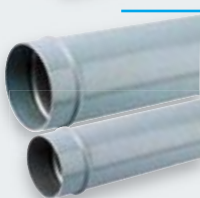
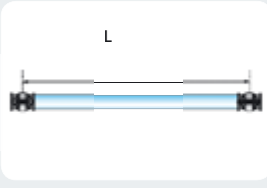

- > Compressor outlets (absorption of vibration)
- > To bypass obstacles and join different levels
- > Expansion loops
- > Max. working pressure for flexible hose used for compressed air:
 - 188 psi from -4 °F to +140 °F
 - 232 psi from -4 °F to +115 °F (please consult us for higher temperature requirements)

- > Max. working pressure for flexible hose used for vacuum: 145 psi
- > Vacuum: 98.7% (29.6" Hg)
- > Working temperature: -4 °F to +140 °F
- > Resistant to mineral and synthetic compressor oils
- > Fire resistant (conforms to ISO 8030 standard for compressed air flexible hose and to EN 12.115 standard for vacuum flexible hose)

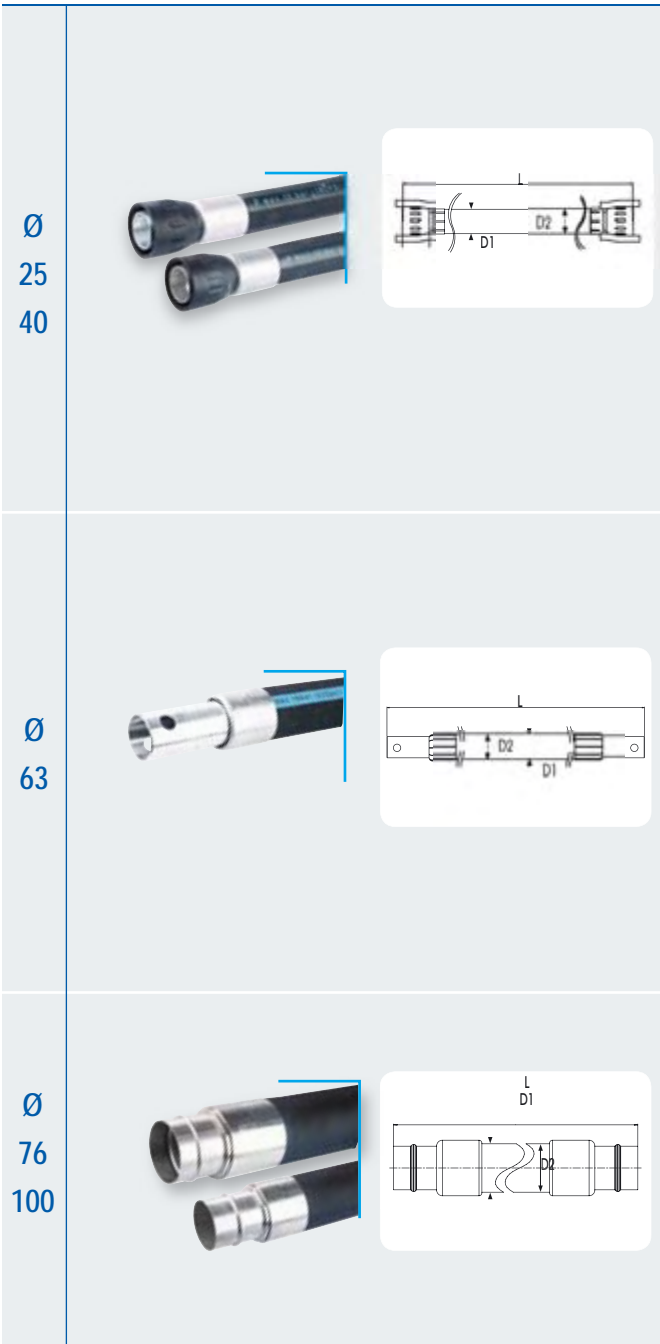

Flexible hose for compressed air systems

Transair	OD (mm)	OD (in)	L (ft)	Min. bend radius (in)	For use with Transair pipe diameter
1001E25 00 01	38	7/8	1' 4"	4	25
1001E25 00 03	38	7/8	5'	4	25
1001E25 00 04	38	7/8	6' 7"	4	25
1001E40 00 02	54	1 1/2	3' 3"	16	40
1001E40 00 04	54	1 1/2	6' 7"	16	40
1001E40 00 05	54	1 1/2	9' 10"	16	40

Flexible hose for vacuum systems

Transair	OD (mm)	OD (in)	L (ft)	Min. bend radius (in)	For use with Transair pipe diameter
1001E25V00 01	36	7/8	1' 4"	3	25
1001E25V00 03	36	7/8	5'	3	25
1001E25V00 04	36	7/8	6' 7"	3	25
1001E40V00 07	52	1 1/2	3' 3"	6 1/2	40
1001E40V00 04	52	1 1/2	6' 7"	6 1/2	40
1001E40V00 05	52	1 1/2	9' 10"	6 1/2	40

Flexible hose for compressed air systems

Transair	OD (mm)	OD (in)	L (ft)	Min. bend radius (in)	For use with Transair pipe diameter
1001E63 00 08	79	2 1/2	4' 7"	12	63
1001E63 00 05	79	2 1/2	9' 10"	25	63
1001E63 00 06	79	2 1/2	13' 1"	25	63

Flexible hose for vacuum systems

Transair	OD (mm)	OD (in)	L (ft)	Min. bend radius (in)	For use with Transair pipe diameter
1001E63V00 05	76	2 1/2	9' 10"	10	63
1001E63V00 06	76	2 1/2	13' 1"	10	63

Flexible hose for compressed air and vacuum systems

Transair	OD (mm)	OD (in)	L (ft)	Min. bend radius (in)	For use with Transair pipe diameter
FP01 L1 01	91	3	4' 9"	14	76
FP01 L1 02	91	3	6' 6"	14	76
FP01 L3 02	116	4	6' 6"	20	100
FP01 L3 03	116	4	9' 10"	20	100

Use two connectors RR01 to connect flexible hoses FP01 to Transair pipe.

Anti whip-lash strap



6698 99 03

Prevents whip-lash should Transair flexible hose be disconnected while under pressure. Conforms to ISO 4414 safety standard.

> Pipe-to-pipe and threaded connectors

The range of Transair pipe-to-pipe and stud connectors provides versatility of design and helps to overcome constraints often encountered with the structure of industrial buildings.

> Quick connection

> Full bore design*

> Interchangeable** and reusable

> Non-flammable materials (UL94-HB standard)

*Consistent inner diameter for both pipe and connectors.

**Applicable to Ø 16.5, Ø 25 and Ø 40

Pipe-to-pipe connector

Transair	ØD	ØG	L	Z
6606 17 00	16.5	34.0	120.5	33.0
6606 25 00	25	44.5	151.5	48.0
6606 40 00	40	67.0	205.0	57.0

Transair	ØD	ØG	L	Z
6606 63 00	63	91.0	171.5	25.0

Pipe-to-pipe connector (clamp and cartridge)

Transair	ØD	L	E1	E2
RR01 L1 00	76	146	104	132
RR01 L3 00	100	146	128	157

Cartridge (spare part)

Transair	ØD	M	N
RP01 L1 00	76	88.7	51.4
RP01 L3 00	100	123	52.7

Pipe-to-pipe connector with vent

Transair	ØD	ØG	L	Z
6676 25 00	25	44.5	151.5	48.0
6676 40 00	40	67.0	205.0	57.0

Transair	ØD	ØG	L	Z
6676 63 00	63	91.0	171.5	25.0

Model supplied with 1/4" threaded fitting and Ø 8 mm push-in connection, complete with blanking plug.

Ø
16.5
25
40

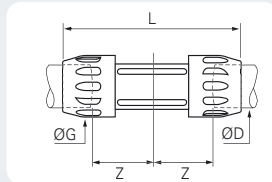

Ø
63

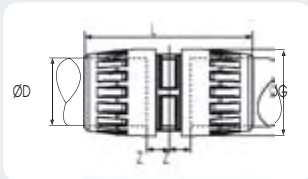

Ø
76
100

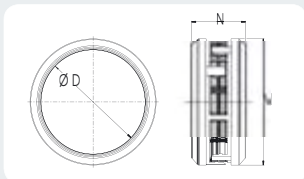
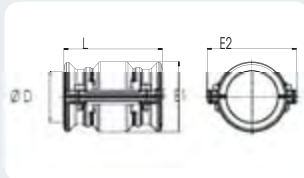

Ø
25
40

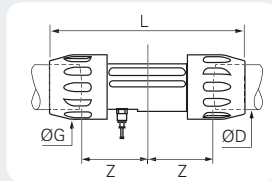

Ø
63

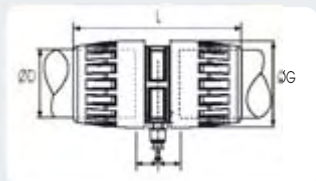

- > Max. working pressure:
 - 188 psi from -4 °F to +140 °F
 - 232 psi from -4 °F to +115 °F
 - (please consult us for higher temperature requirements)
- > Vacuum: 98.7% (29.6" Hg)
- > Working temperature: -4 °F to +140 °F

Ø 16.5 25 40		
-----------------------	---	---

90° elbow

Transair	ØD	ØG	L	Z
6602 17 00	16.5	34.0	58.0	31.0
6602 25 00	25	44.5	68.0	40.0
6602 40 00	40	67.0	107.0	62.0

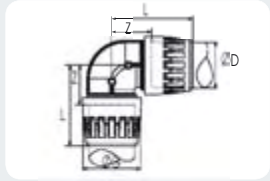
Ø 63		
---------	---	--

Transair	ØD	ØG	L	Z
6602 63 00	63	91.0	122.0	61.0

Ø 76 100		
----------------	---	---

Transair	ØD	H	Z
RX02 L1 00	76	227	189
RX02 L3 00	100	278	221

Use two connectors RR01 to connect 90° elbow RX02 to Transair pipe.

Ø 25 40		
---------------	---	---

45° elbow

Transair	ØD	ØG	L	Z
6612 25 00	25	44.5	57.0	29.0
6612 40 00	40	67.0	90.0	45.0

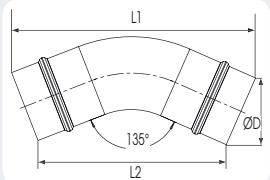
Ø 76 100		
----------------	---	---

Transair	ØD	L1	L2
RX12 L1 00	76	235.5	151.4
RX12 L3 00	100	271.4	184.3

Use two connectors RR01 to connect 45° elbow RX12 to Transair pipe.

> Pipe-to-pipe and threaded connectors

Ø
16.5
25
40

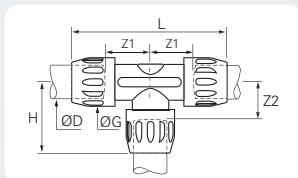

Equal tee

Transair	ØD	G	H	L	Z1	Z2
6604 17 00	16.5	34.0	58.0	120.5	34.0	31.0
6604 25 00	25	44.5	67.5	151.5	48.0	40.0
6604 40 00	40	67.0	102.5	205.0	57.0	57.0

Ø
63

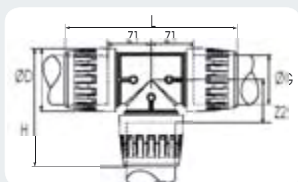

Transair	ØD	G	H	L	Z1	Z2
6604 63 00	63	91.0	122.0	245.0	61.0	61.0

Ø
76
100

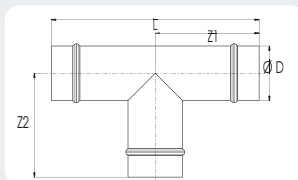

Transair	ØD	L	Z1	Z2
RX04 L1 00	76	290	145	145
RX04 L3 00	100	310	155	135

Use three connectors RR01 to connect equal tee RX04 to Transair pipe.

Ø
63

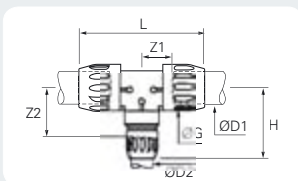

Reducing tee

Transair	ØD1	ØD2	ØG	H	L	Z1	Z2
6604 63 40	63	40	91.0	161.0	245.0	61.0	116.0

Ø
76
100

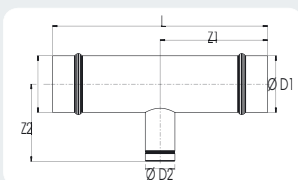

Transair	ØD1	ØD2	L	Z1	Z2
RX24 L1 40	76	40	290	145	104
RX24 L1 63	76	63	290	145	163
RX24 L3 40	100	40	310	155	116,5
RX24 L3 63	100	63	310	155	175,8

Use two connectors RR01 to connect reducing tee RX24 to Transair pipes Ø 76 and Ø 100 and to connect pipe-to-pipe connector 6606 to Transair pipes Ø 40 and Ø 63.

Ø
76
100

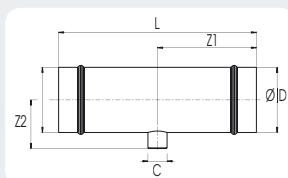

Threaded tee

Transair	ØD	C(in)	L	Z1	Z2
RX20 L1N04	76	1/2	290	145	63
RX20 L3N04	100	1/2	310	155	75.8

Use two connectors RR01 to connect threaded tee RX20 to Transair pipe.

Ø
16.5
25
40

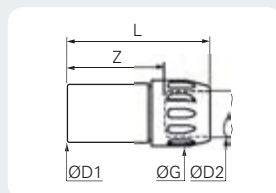

Plug-in reducer

Transair	ØD1	ØD2	ØG	Z	L
6666 17 25	25	16.5	34.0	50.0	77.0
6666 25 40	40	25	44.5	71.0	99.0

Ø
63

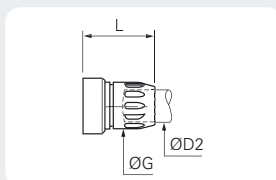

Transair	ØD1	ØD2	ØG	L
6666 40 63	63	40	67.0	112.5

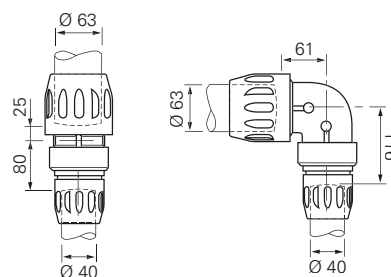

Ø
76
100

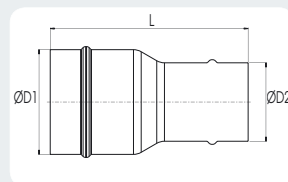

Transair	ØD1	ØD2	L
RX64 L1 63	76	63	230
RX64 L3 63	100	63	250
RX66 L3 L1	100	76	192.5

Use one connector RR01 to connect plug-in reducer RX64 to Transair pipes Ø 76 or Ø 100 and one pipe-to-pipe connector 6606 to connect to Transair pipe Ø 63.

> Pipe-to-pipe and threaded connectors

Ø
16.5
25
40

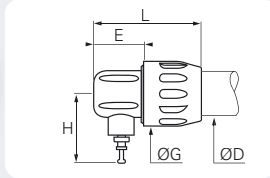

Vented end cap

Transair	ØD	E	ØG	H	L
6625 17 00	16.5	25.5	34.0	45.5	62.5
6625 25 00	25	33.0	44.5	47.0	75.0
6625 40 00	40	34.5	67.0	55.0	98.5

16.5mm: supplied with LF3000 6mm plus.

Model Ø 25, Ø 40 and Ø 63: supplied with LF3000 5/16" (8mm) plug.

Ø
63

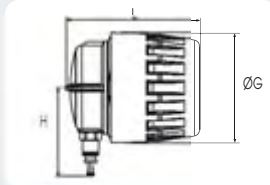

Transair	ØD	E	ØG	H	L
6625 63 00	63	31.0	91.0	74.0	111

16.5mm: supplied with LF3000 6mm plus.

Model Ø 25, Ø 40 and Ø 63: supplied with LF3000 5/16" (8mm) plug.

End cap

Transair	ØD	L
RX25 L1 00	76	99.6
RX25 L3 00	100	107.4

Use one connector RR01 to connect end-cap RX25 to Transair pipe.

Ø
76
100

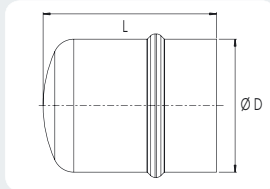

Ø
16.5
25
40

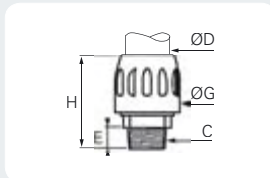









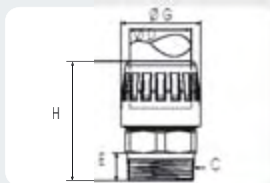

Male threaded connector, NPT thread

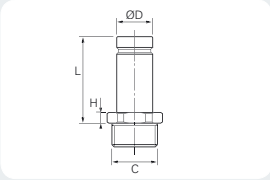
Transair	ØD	C	E	ØG	H
6605 17 14	16.5	1/4"	9.5	34.0	62.5
6605 17 22	16.5	1/2"	15.0	34.0	68.0
6605 25 22	25	1/2"	15.0	44.5	70.5
6605 25 28	25	3/4"	15.0	44.5	71.5
6605 25 35	25	1"	16.0	44.5	71.5
6605 40 35	40	1"	16.0	67.0	111.5
6605 40 43	40	1 1/4"	21.5	67.0	111.5
6605 40 44	40	2"	23	67.0	111.5
6605 40 50	40	1 1/2"	24.5	67.0	114.5

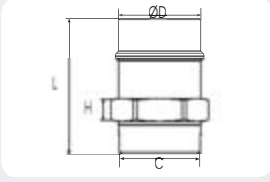
Transair	ØD	C	E	ØG	H
6605 63 44	63	2"	20.0	91.0	118.5
6605 63 41	63	2 1/2"	25.0	91.0	130.5
6605 63 46	63	3"	27	91.0	140.0

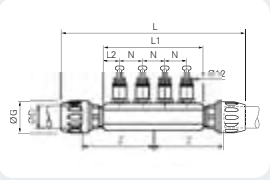
Ø
63

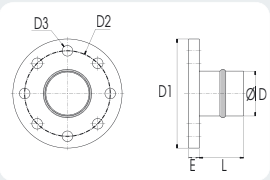

Ø 16.5 25 40			Male adaptor, NPT thread							
			Transair	ØD (mm)	C (in)	L	H			
			6621 17 22	16.5	1/2"	42.2	5.0			
Ø 76			Male adaptor, NPT thread							
			Transair	ØD (mm)	C (in)	L	H			
			RR21 L1N20	76	2 1/2"	125	20			
Ø 25 40			Manifold							
			Transair	ØD	G	L	U	L2	N	Z
			6651 25 12 04	25	44.5	271.0	151.0	23.0	35.0	107.0
Ø 76 100			Flange							
			Transair	ØD	DN	DI	D2	D3	€	L
			RX30 L1 00	76	65	185	145	18	10	75
Ø 76 100			Flange gasket							
			Transair	ØD						For use with flange reference
			EW05 L1 00	76						RX30 L1 00
			Flange bolt kit							
			Transair	C				L		
			EW06 00 01	5/8"				60		
			Contains eight bolts and eight nuts.							

Male adaptor, NPT thread

Transair	ØD (mm)	C (in)	L	H
6621 17 22	16.5	1/2"	42.2	5.0
6621 25 22	25	1/2"	49.0	7.0
6621 25 28	25	3/4"	49.0	7.0
6621 25 35	25	1"	49.0	7.0
6621 40 43	40	1 1/4"	73.7	8.0
6621 40 50	40	1 1/2"	75.7	10.0

Transair	ØD (mm)	C (in)	L	H
RR21 L1N20	76	2 1/2"	125	20
RR21 L1N24	76	3"	125	20

Use one connector RR01 to connect male adaptor RR21 to Transair pipe.

Manifold

Transair	ØD	G	L	U	L2	N	Z
6651 25 12 04	25	44.5	271.0	151.0	23.0	35.0	107.0
6651 40 12 04	40	67.0	400.0	204.0	27.0	50.0	150.0

Supplied with four Ø12 mm plugs.

Flange

Transair	ØD	DN	DI	D2	D3	€	L
RX30 L1 00	76	65	185	145	18	10	75
RX31 L1 00*	76	80	200	160	18	10	75
RX30 L3 00	100	100	220	180	18	10	75
RX31 L3 00*	100	100	220	180	18	10	75

* RX31 dimensions conform to ANSI standards.

Flange gasket

Transair	ØD	For use with flange reference
EW05 L1 00	76	RX30 L1 00
EW05 L3 00	100	RX30 L3 00

Flange bolt kit

Transair	C	L
EW06 00 01	5/8"	60

Contains eight bolts and eight nuts.

> Quick assembly direct feed brackets

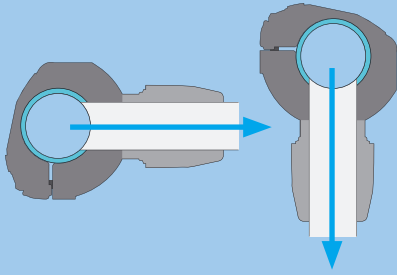

For rigid drops with horizontal take off or for all types of air supply with rigid pipe or flexible hose on an installation which incorporates an efficient air dryer.

- > Optimum flow
- > Compact
- > Well adapted for most original equipment manufacturer (OEM) applications and for use with neutral gases
- > Quick installation without any cutting of pipe

Ø
25
40

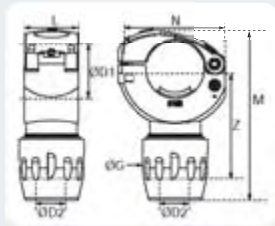

Simple reducing bracket

Transair	ØD1	ØD2	M	G	L	N	Z
RA69 25 17	25	16.5	92	34	37	52	47.5
RA69 40 25	40	25	117	44.5	37	74	61

To drill Transair pipe, use drilling tools 6698 02 01 and 6698 02 02.

Ø
76
100

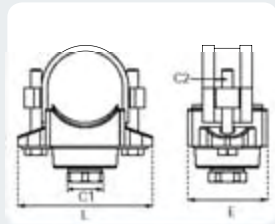

Transair	ØD	C1	C2	E	L
RR63 L1N08	75	1"	M12	50	137
RR63 L3N08	110	1"	M12	80	137

Supplied with Ø 25 - 1" adaptor (6621 25 35).
To drill Transair pipe, use drilling tool EW09.

Ø
25
40

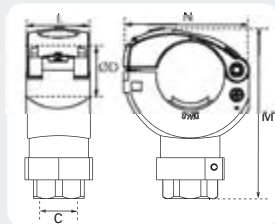

Simple bracket with thread (NPT)

Transair	ØD	C	L	N	M
RA68 25N04	25	1/2"	37	52	86
RA68 40N04	40	1/2"	37	74	100

Supplied with brass plug. To drill Transair pipe, use drilling tools 6698 02 01 and 6698 02 02.

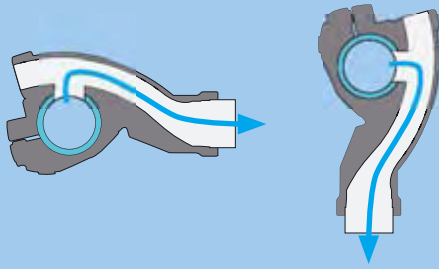

New generation quick assembly brackets are recommended for vertical or horizontal take-offs, using either rigid pipe or flexible hose.

- > Integral water retention device
- > Very high flow
- > Quick installation without any cutting of pipe

Ø
25
40

Quick assembly bracket

Transair	ØDI	ØD2	M	ØG	L	N	Z
6662 25 17	25	16.5	139.5	34	36	63.5	82
6662 25 00	25	25	134	44.5	36	63.5	74
6662 40 17	40	16.5	154	34	37.5	76.5	89
6662 40 25	40	25	149.5	44.5	37.5	76.5	82

To drill Transair pipe, use drilling tools 6698 02 01 and 6698 02 02.

Ø
63

Transair	ØDI	ØD2	M	G	L	N	Z
6662 63 25	63	25	166.5	44.5	50	108.5	75

To drill Transair pipe, use drilling tool 6698 02 02.

Ø
25
40

Quick assembly mini-bracket with female thread (NPT)

Transair	ØDI	C	M	L	N
6663 25 22	25	1/2"	117.5	36	63.5
6663 40 22	40	1/2"	132	37.5	76.5

Supplied with brass plug. To drill Transair pipe, use drilling tools 6698 02 01 and 6698 02 02.

Ø
63

Transair	ØDI	C	M	L	N
6663 63 22	63	1/2"	138.9	50	98.5
6663 63 28	63	3/4"	138.9	50	98.5

Supplied with brass plug. To drill Transair pipe, use drilling tool 6698 02 02.

> Pressurized system outlets

> Ideal for fast assembly of new pressurised outlets, without venting the compressed air system.

> The drilling tool can be used with most standard drills.

We recommend, however, that the pipe system is vented prior to the addition of an outlet. Thanks to the lateral dismantling capability of Transair pipe and the use of quick assembly brackets, this operation can be completed very quickly (less than seven min. for a new outlet) and guarantees the interior cleanliness of the system.

Ø
16.5
25
40



Pressurised system bracket

Transair	ØD
EA98 06 01	25
EA98 06 02	40

Bracket with ball valve (1/2" NPT thread)

Ø
63



Transair	ØD
EA98 06 03	63

Bracket with ball valve (1/2" NPT thread)

Ø
76
100

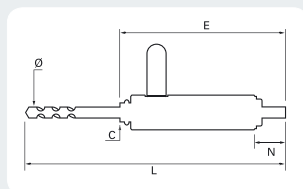

Pressurised system drilling tool

Transair	C	ØD	L	E	N
EA98 06 00	1/2"	13	330.0	154.0	30.5

> 1 or 2 ports

> For wall or machine mounting

> Supplied with brass plug

> Drain outlet 1/4"

> Working pressure:

- 188 psi from -4 °F to +140 °F

- 232 psi from -4 °F to +115 °F (please consult us for higher temperature requirements)

> Non-flammable (conforms to UL94-HB standard)

> Vacuum: 98.7% (29.6" Hg)

> Working temperature: -4 °F to +140 °F

Ø
16.5
25

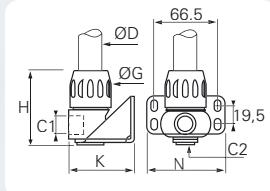

1 port wall bracket

Transair	ØD	C1	C2	G	H	K	N
6683 17 22	16.5	1/2"	1/4"	34	65	70.5	82
6683 25 22	25	1/2"	1/4"	44.5	81	70.5	82

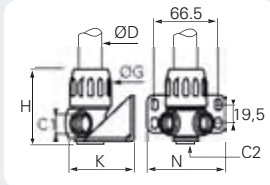

2 port wall bracket

Transair	ØD	C1	C2	G	H	K	N
6684 17 22	16.5	1/2"	1/4"	34	65	74.5	82
6684 25 22	25	1/2"	1/4"	44.5	81	74.5	82

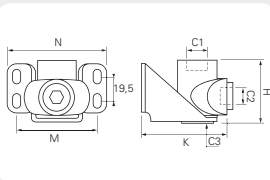

1 port threaded wall bracket

Transair	C1	C2	C3	H	K	M	N
6687 22 22	1/2"	1/2"	1/4"	48	72.5	66.5	82

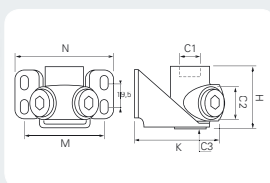

2 port threaded wall bracket

Transair	C1	C2	C3	H	K	M	N
6688 22 22	1/2"	1/2"	1/4"	48	72.5	66.5	82

> Ball valves and butterfly valves

Transair ball valves and butterfly valves placed regularly throughout the system at key locations, such as compressor outlets and upstream of pneumatic tools, allow ease of system isolation and pipe reconfiguration / maintenance.

- > Quick connection
- > Available in lockable version (only in 16.5mm and 25mm)
- > Manual or piloted operation (only in 25mm and 40mm)

Ø
16.5
25

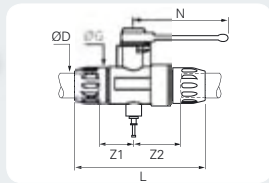

Double female, vented

Transair	ØD	G	L	N	Z1	Z2
4089 17 00	16.5	34.0	120.0	69.5	29.0	42.0
4088 25 14	25	44.5	152.0	108.5	40.0	55.0

Model 4089 17 00: supplied with Ø6 mm plug.
Model 4088 25 14: supplied with Ø8 mm plug.

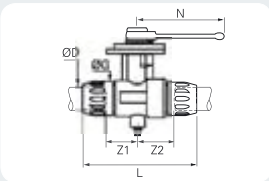

Lockable valve, vented

Transair	ØD	G	L	N	Z1	Z2
4099 17 00	16.5	34.0	121.0	69.0	29.0	42.0
4099 25 00	25	44.5	151.7	108.3	40.0	55.0

Model 4099 17 00: supplied with Ø 6 mm plug.
Model 4099 25 00: supplied with Ø 8 mm plug.

Ø
40

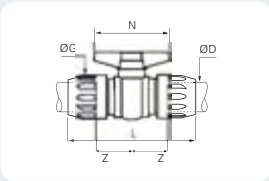

Double female valve

Transair	ØD	G	L	N	Z
4002 40 00	40	67.0	205.0	122.0	57.0

Ø
63

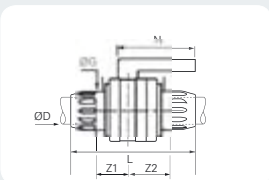

Transair	ØD	G	L	N	Z1	Z2
4002 63 00	63	91.0	278.0	185.0	84.0	98.0

Ø
76
100

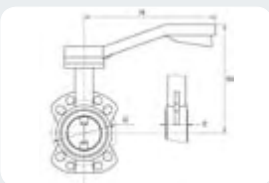

Butterfly Valve

Transair	ØD	DN	G	M	N	E
VR02 L1 00	76	80	145	300	250	50
VR02 L3 00	100	100	180	270	210	56

Model with CE marking. Supplied with screws.

- > **Max. working pressure:**
 - 188 psi from -4 °F to +140 °F
 - 232 psi bar from -4 °F to +115 °F
 - (please consult us for higher temperature requirements)
- > **Vacuum: 98,7%**
(29.6" Hg)
- > **Working temperature: -4 °F to +140 °F**

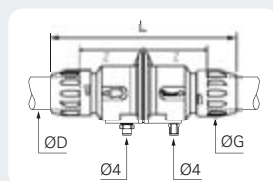

Remote control shut-off valve

Transair	ØD	G	L	Z
4230 00 40	40	67	261	85.0

Min. working pressure: 58 psi • Max. working pressure: 235 psi
 The Transair remote control shut-off valve is supplied with a plugged vent hole. This allows venting of the downstream network, after closing the valve.

Ø
40

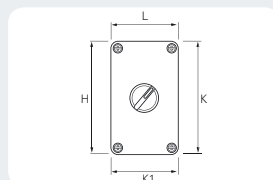

Pilot kit

Transair	H	K	K1	L
4299 03 01	145	106	70	82

This pilot kit comprises: pneumatic ON/OFF switch (maximum 235 psi operating pressure), twin 4 mm OD polyurethane tube (length 10 m) and plastic box.

> Tools

> Practical tools for the installation and extension of Transair air pipe systems.

> Presented in a carrying case, or available as separate parts.

Ø
16.5
to
63



Tool case

Transair	H	L	I
6698 00 03	315	290	105

This tool case simplifies the use and transportation of tools. It contains all the tools necessary for completing an installation:

- Drilling jigs 6698 01 01 and 6698 01 02
- Drilling tools 6698 02 01 and 6698 02 02
- Cutter for rigid pipe 6698 03 01
- Chamfer tool 6698 04 01
- Deburring tool 6698 04 02
- Set of tightening spanners 6698 05 03
- Marking tool 6698 04 03

Ø
16.5
to
100



Pipe cutter

Transair	L	H	Used for Transair pipe
6698 03 01	230	98	Ø 16.5 - 25 - 40 - 63
EW08 00 01	360	155	Ø 63 - 76 - 100

Ø
16.5
to
40

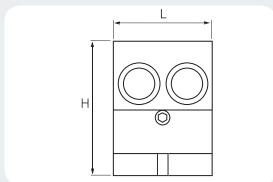

Drilling jig for rigid aluminum pipe

Transair	H	L
6698 01 01	120	80

After drilling, de-burr and clean the pipe.



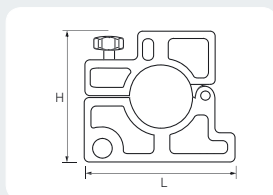



Ø
63

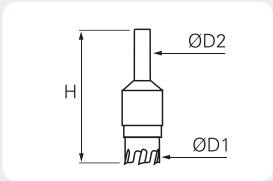

Drilling jig for rigid aluminum pipe

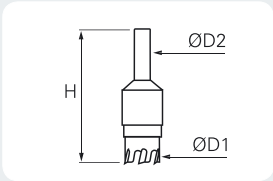
Transair	H	L
6698 01 02	134	155

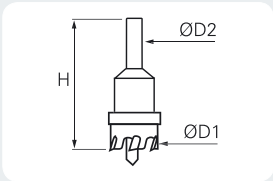
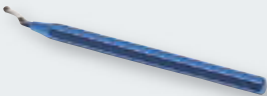
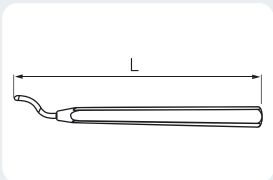
After drilling, de-burr and clean the pipe.

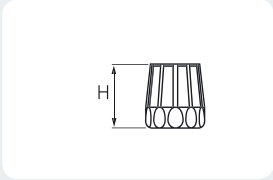
<p>Ø 25</p>	 	<p>Drilling tool for aluminum pipe</p> <table border="1"> <thead> <tr> <th>Transair</th> <th>ØD1</th> <th>ØD2</th> <th>H</th> <th>For Transair pipe</th> </tr> </thead> <tbody> <tr> <td>6698 02 02</td> <td>16</td> <td>12</td> <td>71</td> <td>Ø 25mm</td> </tr> </tbody> </table> <p>Drilling tool 6698 02 02 allows the installation of Ø 25 Transair brackets. Can be used with all types of drill.</p>	Transair	ØD1	ØD2	H	For Transair pipe	6698 02 02	16	12	71	Ø 25mm
Transair	ØD1	ØD2	H	For Transair pipe								
6698 02 02	16	12	71	Ø 25mm								
<p>Ø 40 63</p>	 	<table border="1"> <thead> <tr> <th>Transair</th> <th>ØD1</th> <th>ØD2</th> <th>H</th> <th>For Transair pipe</th> </tr> </thead> <tbody> <tr> <td>6698 02 01</td> <td>22</td> <td>12</td> <td>71</td> <td>Ø 40 - 63mm</td> </tr> </tbody> </table> <p>Drilling tool 6698 02 01 allows the installation of Ø 40 and Ø 63 Transair brackets. It is also used to create the two holes needed for double-clamp ring connectors when cutting to length Ø 63 Transair pipe.</p>	Transair	ØD1	ØD2	H	For Transair pipe	6698 02 01	22	12	71	Ø 40 - 63mm
Transair	ØD1	ØD2	H	For Transair pipe								
6698 02 01	22	12	71	Ø 40 - 63mm								
<p>Ø 76 100</p>	 	<table border="1"> <thead> <tr> <th>Transair</th> <th>ØD1</th> <th>ØD2</th> <th>H</th> <th>For Transair pipe</th> </tr> </thead> <tbody> <tr> <td>EW09 00 30</td> <td>30</td> <td>12</td> <td>71</td> <td>Ø 76 - 100mm</td> </tr> </tbody> </table> <p>Drilling tool EW09 00 03 allows the installation of Ø 76 and Ø 100 Transair direct feed brackets. After drilling, it is important to de-burr and clean the pipe.</p>	Transair	ØD1	ØD2	H	For Transair pipe	EW09 00 30	30	12	71	Ø 76 - 100mm
Transair	ØD1	ØD2	H	For Transair pipe								
EW09 00 30	30	12	71	Ø 76 - 100mm								
<p>Ø 16.5 to 100</p>	 	<p>Deburring tool for aluminum pipe</p> <table border="1"> <thead> <tr> <th>Transair</th> <th>L</th> </tr> </thead> <tbody> <tr> <td>6698 04 02</td> <td>140</td> </tr> </tbody> </table>	Transair	L	6698 04 02	140						
Transair	L											
6698 04 02	140											
<p>Ø 16.5 25 40</p>	 	<p>Chamfer tool for aluminum pipe</p> <table border="1"> <thead> <tr> <th>Transair</th> <th>H</th> </tr> </thead> <tbody> <tr> <td>6698 04 01</td> <td>64</td> </tr> </tbody> </table> <p>For 16.5, 25 and 40mm.</p>	Transair	H	6698 04 01	64						
Transair	H											
6698 04 01	64											

Ø
16.5
25
40

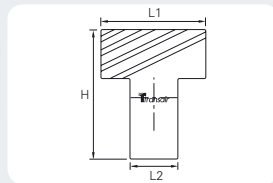

Marking tool for aluminum pipe

Transair	H	L1	L2
6698 04 03	88	73	33

The marking tool enables connection guidelines to be marked on cut lengths of Transair pipe. These marks indicate the insertion limits of the pipe into each fitting in order to ensure good airtight connection and security of grip.

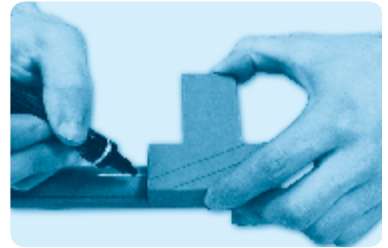

Ø
63



Spanner wrenches for Ø 63mm fittings

Transair
6698 05 03

This set includes two tightening spanners.

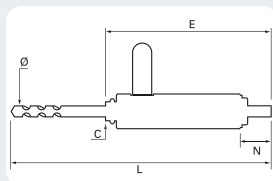

Pressurised system drilling tool

Transair	C	ØD	L	E	N
EA98 06 00	1/2"	13	330.0	154.0	30.5



Portable tool kit

Transair	V
EW01 00 02	110

This case contains: one portable tool, one 12V battery and battery charger.

Ø
76
100

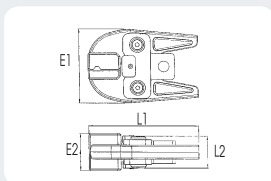

Jaws for portable tool

Transair	ØD	E1	E2	L1	L2
EW02 L1 00	76	103	52	154	46
EW02 L3 00	100	103	71	154	46



12V battery for portable tool

Transair
EW03 00 01

> Fixture accessories

- > Easy adaptation for all pipework configurations
- > For suspension of pipes, from walls, partitions, beams, cable trays, Canalis electrical installations, etc, vertically or horizontally
- > Perfectly suited for use with Transair systems
- > Non-flammable (conforms to UL94V-2 standard)

Fixing clip for rigid pipe

Transair	ØD	C	HI	H	K	L
6697 17 01	16.5	1/4"	46	61	30	32.5
6697 25 01	25	1/4"	46	65.5	30	38.5
6697 40 01	40	1/4"	46	74.5	30	50

Transair fixing clips are desigbnd to bear a maximum weight of 44lbs.

However, to ensure good stability fo the system, we recommend the use of at least two clips per pipe i.e.:

- maximum 5 ft space between clips for 10 ft lenghts of pipe
- maximum 10 ft space between clips for 20 ft lenghts of pipe

Use only this clip for fixing Transair rigid pipe, all other type of pipe clips are to be avoided. Fix the clip to a rigid support (U-channel, cable tray) to allow for expansion while retaining the pipe.

Transair	ØD	C	HI	H	K	L
6697 63 01	63	3/8"	90	127.5	30	73.5

Transair fixing clips are desigbnd to bear a maximum weight of 44lbs.

However, to ensure good stability fo the system, we recommend the use of at least two clips per pipe i.e.:

- maximum 5 ft space between clips for 10 ft lenghts of pipe
- maximum 10 ft space between clips for 20 ft lenghts of pipe

Use only this clip for fixing Transair rigid pipe, all other type of pipe clips are to be avoided. Fix the clip to a rigid support (U-channel, cable tray) to allow for expansion while retaining the pipe.

Transair	ØD	C
ER01 L1 00	76	3/8"
ER01 L3 00	100	3/8"

Transair fixing clips are desigbnd to bear a maximum weight of 44lbs.

However, to ensure good stability fo the system, we recommend the use of at least two clips per pipe i.e.:

- maximum 5 ft space between clips for 10 ft lenghts of pipe
- maximum 10 ft space between clips for 20 ft lenghts of pipe

Use only this clip for fixing Transair rigid pipe, all other type of pipe clips are to be avoided. Fix the clip to a rigid support (U-channel, cable tray) to allow for expansion while retaining the pipe.

Spacer

Transair	ØD	H	HI	K	L
6697 00 03	11	49.5	44	34	33

This spacer, in association with a Transair pipe clip, allows consistent alignment of pipes when different diameters of pipe are run concurrently in the same line.



Threaded rod adaptor

Transair	C1	C2	€	F	H
0169 00 05 00	1/4"	3/8"	16	13	30

The use of this adaptor facilitates the suspension of Transair 6.5, 25 or 40mm with 3/8" threaded rod.

Ø
16.5
25
40

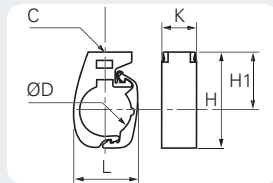

Ø
63

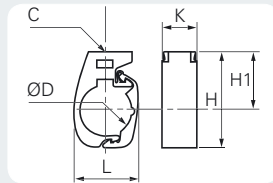

Ø
76
100

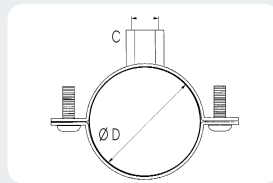

Ø
16.5
to
63

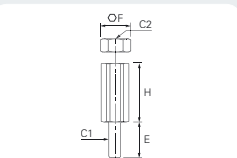
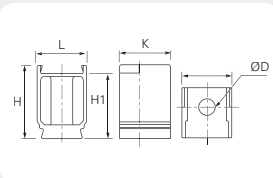

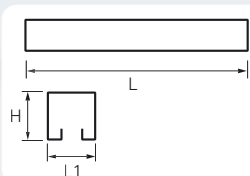
**Transair****6699 01 01****H**

25

L(ft)

6'6"

U

25

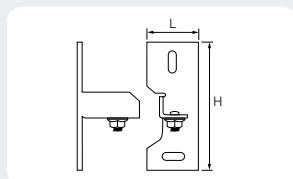
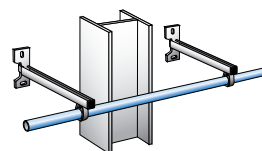
U-channel**U-channel fixing bracket****Transair****6699 01 02****H**

106

L

40

This set comprises:

- 1 bracket
- 1 fixing bolt & nut
- 1 nut
- 1 rail profile end cap

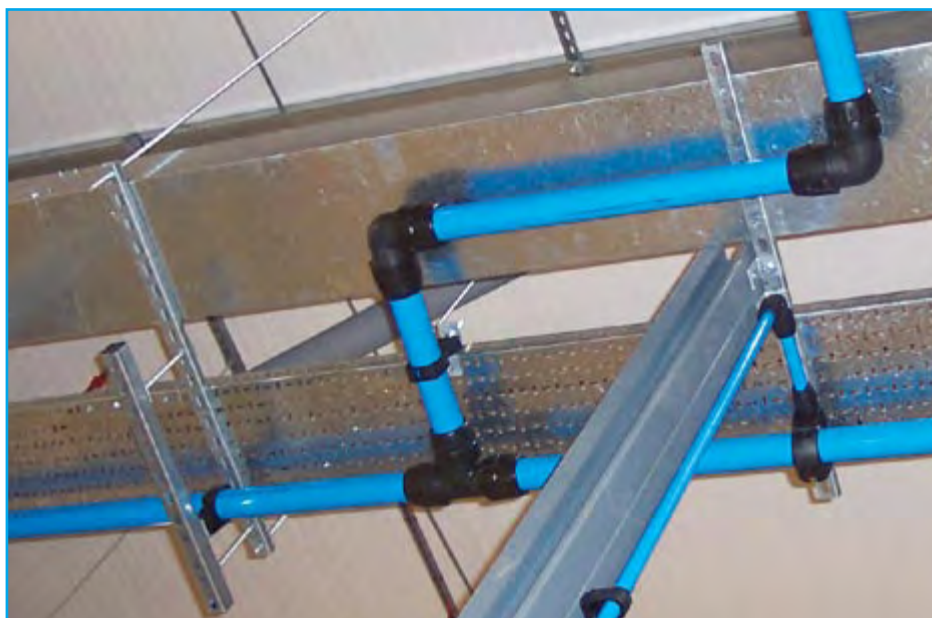

> Hose reels – Blowgun

Hose reels

- > Optimize productivity and the safety of your work area
- > Prevent hose damage occurring on the workshop floor
- > Maximum working pressure, dependant on the model:
 - 6698 11 11: 250 psi
 - 6698 10 02: 250 psi
- > Working temperature: -4° F to +14° F

Blowgun

- > Dusting, cooling and drying components
- > Removing swarf
- > Cleaning machinery
- > Max. working pressure: 174 psi maximum
- > Working temperature: -40° F to +140° F

25 ft

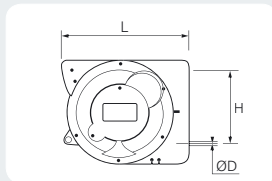

Light series hose reel

Transair	Hose i.d. (in)	Max. Pressure (psi)	H	L
6698 11 11	3/8	250	251	300

Hose clutch with free return
Outlet connection 1/4 male - 3/8" inlet

50 ft

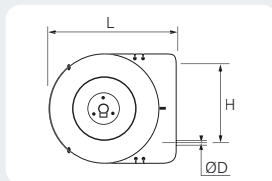

Light series hose reel

Transair	Hose i.d. (in)	Max. Pressure (psi)	H	L
6698 11 12	3/8	250	251	390

Hose clutch with free return
Outlet connection 1/4 male - 3/8" inlet



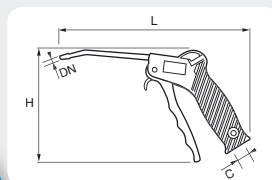





Blowgun



Transair	C (in)	DN	H	L
EA58 00 14	1/4	3.5	125.5	223.0

- > For quick and repetitive connection and disconnection
- > 100% safety – ISO 4414 and European EN 983 compliant
- > Very high flow, extremely low pressure loss
- > Lightweight and robust
- > Improved hand grip
- > Fast vent time

- > Male thread with integral seal
- > Suitable fluids: compressed air, argon, nitrogen (please consult us for other fluids)
- > Max. working temperature: 232 psi
- > Working temperature: from -4 °F to +140 °F

	Male NPT	Female NPT	Coupler with hosetail
ISO B 1/4" Safety	 Transair C CP05 U1N02 1/4" CP05 U1N03 3/8" CP05 U1N04 1/2"	 Transair C CP15 U1N02 1/4" CP15 U1N03 3/8" CP15 U1N04 1/2"	 Transair ØD (mm) CP21 U1 06 6 CP21 U1 08 8 CP21 U1 10 10
ISO B 3/8" Safety	 Transair C CP05 U2N02 1/4" CP05 U2N03 3/8" CP05 U2N04 1/2"	 Transair C CP15 U2N02 1/4" CP15 U2N03 3/8" CP15 U2N04 1/2"	 Transair ØD (mm) CP21 U2 08 8 CP21 U2 10 10 CP21 U2 13 13
ARO 1/4" Safety	 Transair C CP05 A1N02 1/4" CP05 A1N03 3/8" CP05 A1N04 1/2"	 Transair C CP15 A1N02 1/4" CP15 A1N03 3/8" CP15 A1N04 1/2"	 Transair ØD (mm) CP21 A1 06 6 CP21 A1 08 8 CP21 A1 10 10



ISO B 1/4"
 ISO 6150 B
 AFNOR NF 49-053
 US.MIL.C4109
 CEJN 310
 RECTUS 23-24

ISO B 3/8"
 ISO 6150 B
 AFNOR NF 49-053
 US.MIL.C4109
 CEJN 430
 RECTUS 30

ARO 1/4"
 ARO 210
 CEJN 300
 ORION 44510
 PARKER 50
 RECTUS 14-22

Flow curve – pressure loss

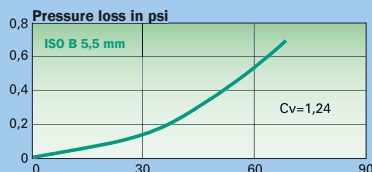

Flow in Nm³/h
 To convert Nm³/h to cfm, use a coefficient of 0.588



Flow in Nm³/h
 To convert Nm³/h to cfm, use a coefficient of 0.588









> Composite automatic safety couplers

Transair composite automatic couplers comply with worldwide ISO 4414 and European EN 983 safety standards. Disconnection is by a double twist of the sleeve.

1st rotation in direction of the arrow: pressure rapidly vented out, plug side.



2nd rotation in direction of the arrow: safe disconnection of body and plug.

<p>ISO B 1/4"</p>		<p>Male plug NPT</p> <p>Transair C</p> <table border="1"> <tr><td>CA84 U1N02</td><td>1/4"</td></tr> <tr><td>CA84 U1N03</td><td>3/8"</td></tr> </table>	CA84 U1N02	1/4"	CA84 U1N03	3/8"		<p>Female plug NPT</p> <p>Transair C</p> <table border="1"> <tr><td>CA83 U1N02</td><td>1/4"</td></tr> <tr><td>CA83 U1N03</td><td>3/8"</td></tr> </table>	CA83 U1N02	1/4"	CA83 U1N03	3/8"		<p>Plug with hosetail</p> <p>Transair ØD (mm)</p> <table border="1"> <tr><td>CA94 U1 06</td><td>6</td></tr> <tr><td>CA94 U1 08</td><td>8</td></tr> <tr><td>CA94 U1 10</td><td>10</td></tr> </table>	CA94 U1 06	6	CA94 U1 08	8	CA94 U1 10	10
CA84 U1N02	1/4"																			
CA84 U1N03	3/8"																			
CA83 U1N02	1/4"																			
CA83 U1N03	3/8"																			
CA94 U1 06	6																			
CA94 U1 08	8																			
CA94 U1 10	10																			
<p>ISO B 3/8"</p>		<p>Male plug NPT</p> <p>Transair C</p> <table border="1"> <tr><td>CA84 U2N02</td><td>1/4"</td></tr> <tr><td>CA84 U2N03</td><td>3/8"</td></tr> </table>	CA84 U2N02	1/4"	CA84 U2N03	3/8"		<p>Female plug NPT</p> <p>Transair C</p> <table border="1"> <tr><td>CA83 U2N02</td><td>1/4"</td></tr> <tr><td>CA83 U2N03</td><td>3/8"</td></tr> </table>	CA83 U2N02	1/4"	CA83 U2N03	3/8"		<p>Probe with hosetail</p> <p>Transair ØD (mm)</p> <table border="1"> <tr><td>CA94 U2 08</td><td>8</td></tr> <tr><td>CA94 U2 10</td><td>10</td></tr> <tr><td>CA94 U2 13</td><td>13</td></tr> </table>	CA94 U2 08	8	CA94 U2 10	10	CA94 U2 13	13
CA84 U2N02	1/4"																			
CA84 U2N03	3/8"																			
CA83 U2N02	1/4"																			
CA83 U2N03	3/8"																			
CA94 U2 08	8																			
CA94 U2 10	10																			
CA94 U2 13	13																			
		<p>Male plug NPT</p> <p>Transair C</p> <table border="1"> <tr><td>CA84 A1N02</td><td>1/4"</td></tr> <tr><td>CA84 A1N03</td><td>3/8"</td></tr> </table>	CA84 A1N02	1/4"	CA84 A1N03	3/8"		<p>Female plug NPT</p> <p>Transair C</p> <table border="1"> <tr><td>CA83 A1N02</td><td>1/4"</td></tr> <tr><td>CA83 A1N03</td><td>3/8"</td></tr> </table>	CA83 A1N02	1/4"	CA83 A1N03	3/8"								
CA84 A1N02	1/4"																			
CA84 A1N03	3/8"																			
CA83 A1N02	1/4"																			
CA83 A1N03	3/8"																			

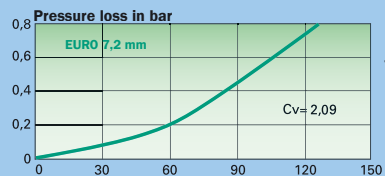

Flow in Nm³/h
To convert Nm³/h to cfm, use a coefficient of 0.588



Flow in Nm³/h
To convert Nm³/h to cfm, use a coefficient of 0.588

**ENERGY
SAVINGS**

Consistent high quality
internal surface
> CLEAN AIR

Full flow connection and low friction
internal surface of the pipe
> HIGH FLOW RATE PERFORMANCE

Calibrated pipe diameter
> OPTIMUM SEALING



**COMPONENTS
GUARANTEED
FOR
2 YEARS**

SAFETY

> non-flammable
materials

EASIER

HANDLING

Pipes and fittings are supplied ready for immediate installation
> NO PREPARATION REQUIRED

Quick assembly - no need to weld, solder, glue, crimp or thread
> TIME SAVING

Easy to assemble



COMPLETELY ADAPTABLE

> removeable and reusable components

HIGH RESISTANCE TO

- > corrosion
- > aggressive environments
- > mechanical shocks
- > thermal variations
- > U.V.
- > compressor oil carry over (mineral or synthetic)

> Installation guide

Essential instructions		
	Installation instructions	40
	Sound engineering practice for the optimization of an air pipe system	41
Aluminum pipe		
	General	42
	Aluminum pipe section	44
Pipe-to-pipe connectors		
	General	48
	Connection / Disconnection	50
	Practical examples	53
	Do's / Don'ts	57
Quick assembly brackets		
	General	59
	Installing a quick assembly bracket	60
	Practical examples	63
Flexible hose		
	General	65
	System connection	66
	Do's / Don'ts	69
Fixture accessories		
	Attachments	70
	Supporting a Transair system	72
Practical information		
	Z dimensions	74
	Expansion / Contraction	75
	Conversion charts	79
Transair in use		81

> The golden rules of installation

> Installation instructions

> General

Prior to the installation of a Transair compressed air distribution system, the installer should ensure that the installation area complies with any regulations applicable to areas exposed to explosive hazards (in particular the effect of static electricity in a silo area). Transair should be installed downstream of the compressed air receiver, or after the dryer. Flexible Transair hose can be installed at the start of the system in order to eliminate any sources of vibration and to facilitate maintenance operations. When maintaining or modifying a Transair system, the relevant section should be vented prior to the commencement of any work. Installers should use only Transair components and accessories, in particular Transair pipe clips and fixture clamps. The technical properties of the Transair components, as described in the Transair catalog, must be respected.

> Pressurizing the system

Once the Transair installation has been installed and prior to pressurizing, the installer should complete all tests, inspections and compliance checks as stated in any contract and according to sound engineering practice and current local regulations.

> Transair pipe and hoses

Transair pipe should be protected from mechanical impact, particularly if exposed to collision with fork-lift trucks or when sited in an environment with moving overhead loads. Similarly, rotation of the pipe and pipe supports should be avoided. Transair pipe must not be welded. Flexible Transair hoses should be used in accordance with the recommendations of the installation guidelines.

Note: In certain situations, Transair aluminum pipe may be formed with a bend - please contact us for further information.

> Expansion / contraction

Expansion and contraction of the system should be calculated prior to installation. The system designer and installer should calculate the elongation or retraction of each Transair line according to the recommendations in this installation guide.

> Component assembly

Transair components are provided with assembly instructions for their correct use - simply follow the methods and recommendations stated in this document.

> Transair installations - situations to avoid

- > installation within a solid mass (concrete, foam, etc.)
- > the hanging of any external equipment to Transair pipe
- > the use of Transair for earthing, or as a support for electrical equipment
- > exposure to chemicals that are incompatible with Transair components (please contact us for further details)

> Sound engineering practice for the optimization of an air pipework system

> When installing a Transair system, the work should be performed in accordance with good engineering practice.

> Bends and bypasses represent sources of pressure drop. To avoid excessive pressure loss, use modular consoles to offset the network and to bypass obstacles. Keep in-line pipe diameter reductions to a minimum.

> Maintain a consistent level of good quality air by use of adequate filtration at the compressor outlet.

> The diameter of the pipe will influence pressure drop and the operation of point-of-use equipment. Select the diameter according to the required flow rate and acceptable pressure drop at the point of use.

> Position drops should be as close as possible to the point of use.

> Transair aluminum pipe

> General



Ø 16.5

Deburred and chamfered pipe



Ø 25

Deburred and chamfered pipe

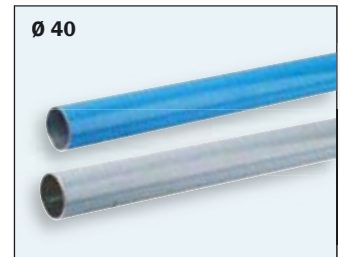

Ø 40

Deburred and chamfered pipe

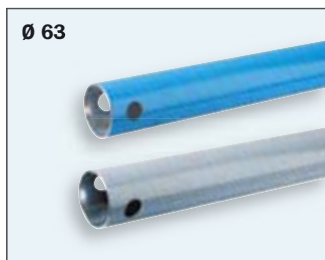

Ø 63

Pipe pre-drilled at each end with two 22 mm diameter holes, deburred and chamfered



Ø 76

Pipe lugged at each end, deburred and chamfered



Ø 100

Pipe lugged at each end, deburred and chamfered

> Presentation

Transair aluminum pipe is supplied ready for use. No particular preparation (cutting, deburring, chamfering, etc.) is required.

Thanks to the rigidity of Transair aluminum pipe, temperature-related expansion / contraction is reduced to a minimum. The Transair network retains its straightness, and hence its performance, over time (reduction of pressure drop caused by surface friction).

Transair aluminum pipe is calibrated and fits perfectly with all Transair components. Each connection is automatically secured and the seal is optimized, which minimizes corrosion to the internal surface

Transair aluminum pipe has a protective powder coating (QUALICOAT certified) and is thus protected from external corrosion. Its color allows the network to be immediately identified and gives a clean and aesthetic overall appearance.

Standard colors available:

- blue (RAL 5012/BS1710)
- grey (RAL 7001)

(please contact us for other colors)

Transair aluminum pipe is available in six diameters and two lengths.

> Applications

Transair Ø 16.5 - Ø 25 - Ø 40 - Ø 63 - Ø 76 - Ø 100 aluminum pipe has been specially designed for compressed air, vacuum and inert gases (argon, nitrogen) - please contact us for other fluids.

> Marking

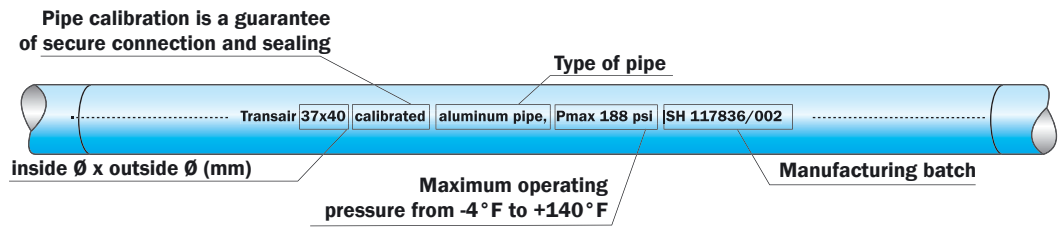

The transported fluid can be instantly identified by the color of the pipe

- ex: Blue pipe → compressed air network
 ex: Grey pipe → vacuum network

> Connection indicator

Only on Ø 16.5 - Ø 25 - Ø 40 aluminum pipe



> Drilling locator: mark lines for correct drilling

Only on Ø 16.5 - Ø 25 - Ø 40 - Ø 63 aluminum pipe

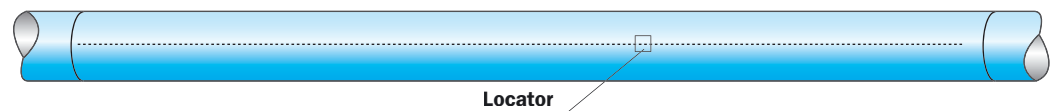

Drilling locators are used to correctly position Transair brackets onto the pipe. There are two locators on each pipe. The second locator is used to position a second bracket perpendicular to a first bracket.

> Transair aluminum pipe

> Aluminum pipe section

> Ø 16.5
Ø 25 - Ø 40

> Tools

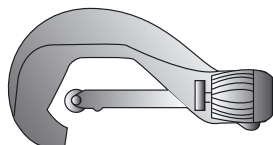

Pipe cutter for aluminum pipe
ref. 6698 03 01



Chamfer tool for aluminum pipe
ref. 6698 04 01



Deburring tool for aluminum pipe
ref. 6698 04 02



Marking tool for aluminum pipe
ref. 6698 04 03

> Procedure

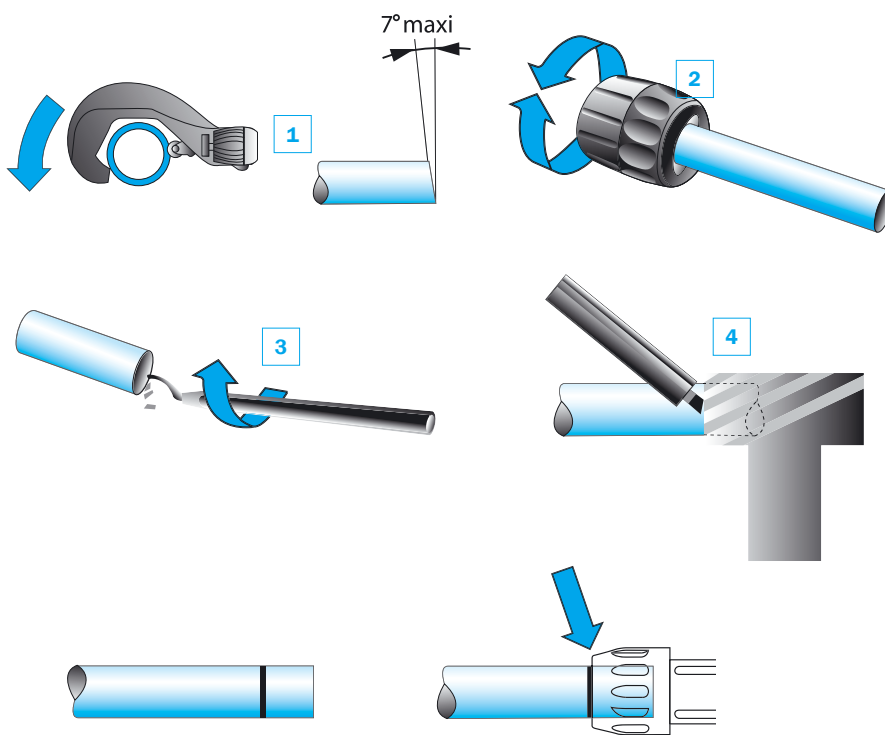

- 1 - Cutting the pipe:
- place the pipe in the pipe cutter
 - position the blade onto the pipe
 - rotate the pipe cutter around the pipe while gently tightening the wheel

- 2 - Carefully chamfer the outer edges
- 3 - Also deburr the inner end of the pipe
- 4 - Trace the connection indicator using the marking tool

The insertion lengths for Ø 16.5 - Ø 25 - Ø 40 connectors are 25 mm, 27 mm and 45 mm respectively, with the exception of the end cap, ref. 6625, for which the insertion lengths are of 39 mm, 42 mm and 64 mm respectively.

> Ø 63

> Tools

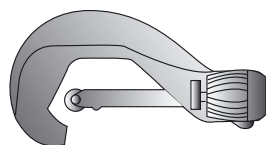

Pipe cutter for aluminum pipe
ref. 6698 03 01



File



Deburring tool for aluminum pipe
ref. 6698 04 02

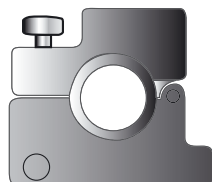

Drilling jig for aluminum pipe
ref. 6698 01 02



Drilling tool for aluminum pipe
ref. 6698 02 01

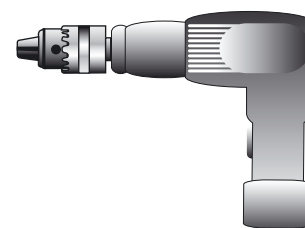

Drill

> Procedure

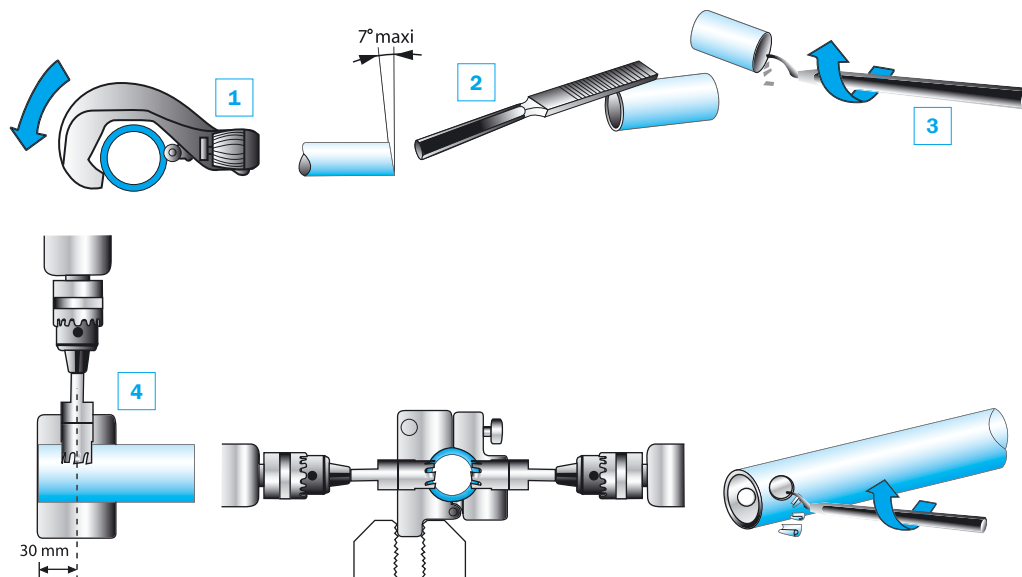

1 - Cutting the pipe:

- place the pipe in the pipe cutter
- position the blade on the pipe
- rotate the pipe cutter around the pipe while gently tightening the wheel

2 - Carefully chamfer the outer edges

3 - Also deburr the inner end of the pipe

- 4 - Drill the two clamp holes using the drilling jig (6698 01 02) and the Ø 22 mm drilling tool (6698 02 01). Loosen the jig, release the pipe, then deburr both holes. Ensure that all outer and inner surfaces are smooth and clear of burrs and potential sharp edges.

> Transair aluminum pipe

> Aluminum pipe section

> Ø 76 - Ø 100

> Tools

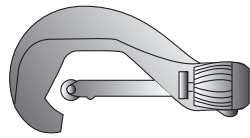

Pipe cutter for aluminum pipe
ref. EW08 00 01

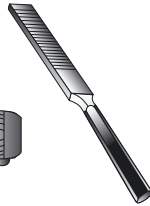

File



Portable tool kit ref.
EW01 00 02 (110V)



Pipe forming jaw set ref.
EW02 L1 00 (Ø 76) or
EW02 L3 00 (Ø 100)

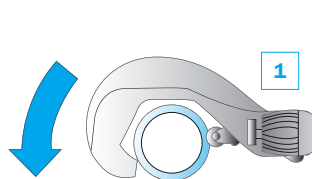

- 1 - Cutting the pipe:
- place the pipe in the pipe cutter
 - position the blade on the pipe
 - rotate the pipe cutter around the pipe while gently tightening the wheel

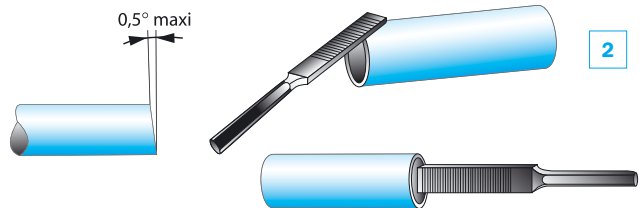

- 2 - Carefully deburr and chamfer the outer and inner edges of the pipe with a file

> Procedure



Open the retaining pin at the front of the machine by pressing the jaw release button*

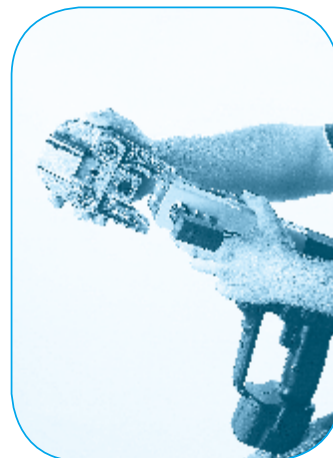

Place the jaws in the housing



Lock in position by closing the retaining pin

3 - Creating the lugs for Ø 76 or Ø 100 cut pipe

> Procedure

3

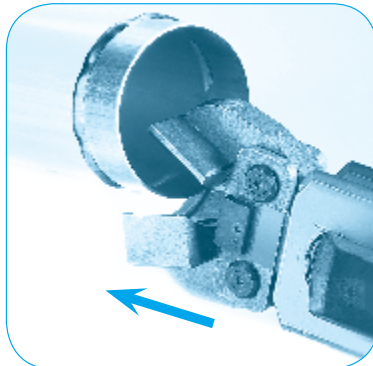

Manually open the jaws of the clamp and insert the aluminum pipe into the clamp as far as it will go

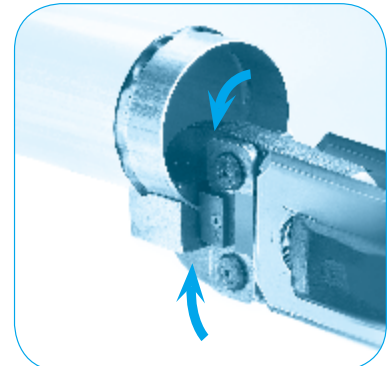

Release the jaws. Press the trigger and crimp the tube until a 'snap' sound is heard

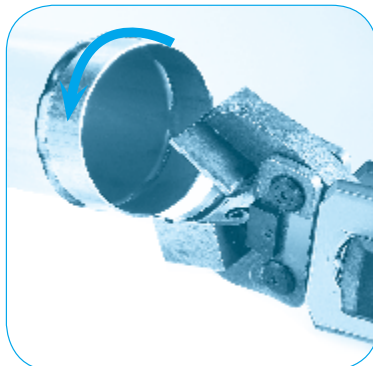

Re-open the two jaws to remove the pipe and rotate the pipe slightly

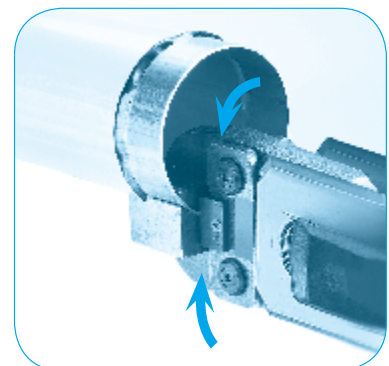

Renew the operation until the required minimum number of lugs for each diameter is achieved

	Ø 76	Ø 100
Min. number of lugs	<p>6</p>	<p>7</p>

Important: Do not overlap the lugs!

> Transair connectors

> General

> Ø 16.5
Ø 25
Ø 40

Instant connection by means of a gripping ring

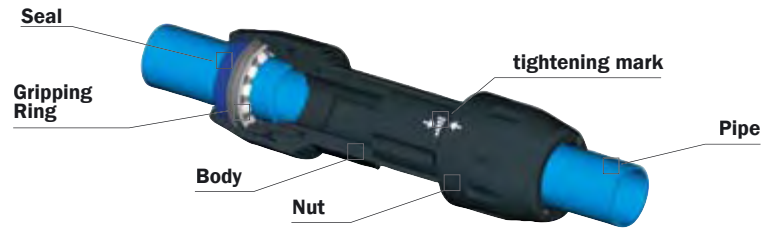

The Ø 16.5 - Ø 25 - Ø 40 connectors instantly connect to Transair aluminum pipe. Simply insert the pipe into the connector up to the connector insertion mark. The internal gripping ring is then automatically secured and the connection is complete.

> Ø 63

Double clamp quick-fit connection



The Ø 63 connectors are quickly secured to Transair aluminum pipe by means of a double clamp, which makes the connector fully integrated with the pipe. Connection is achieved by simply tightening the nut.

> Ø 76
Ø 100

Clamp quick-fit connection

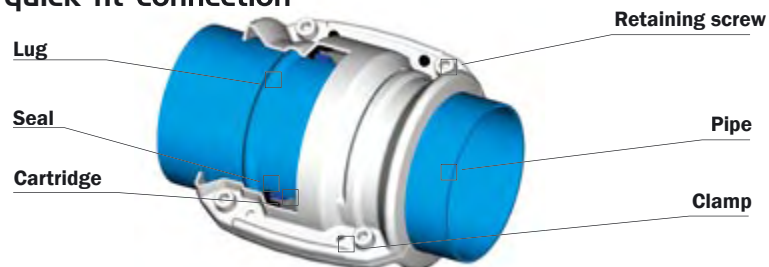

The Ø 76 and Ø 100 clamps secure instantly to Transair aluminum pipe. Simply position the formed pipe within the Transair cartridge, which acts as a seal. Close the Transair clamp to secure the connection and finally tighten the four retaining screws.

There are important visual markings on the bodies and nuts of Transair \varnothing 16.5, \varnothing 25 and \varnothing 40 connectors. These are represented by solid and empty arrows and indicate the optimum torque. When assembling Transair connectors, the nuts are tightened to a pre-defined torque on the body of the connector. This torque guarantees the seal and safety of each connection.

There is no need to loosen the nuts prior to joining \varnothing 16.5, \varnothing 25 and \varnothing 40 connectors to Transair aluminum pipe.

> **Pre-assembled tightening indicators for \varnothing 16.5, \varnothing 25 and \varnothing 40 connectors**

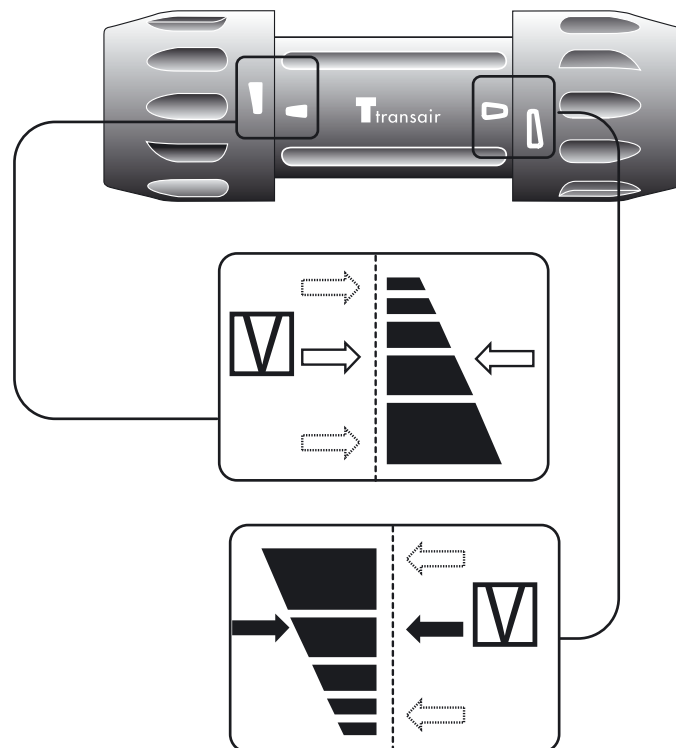

Before using \varnothing 16.5, \varnothing 25 or \varnothing 40 connectors, ensure that the arrow marks are correctly aligned with each other.

> Transair connectors

> Connection / Disconnection

Connection

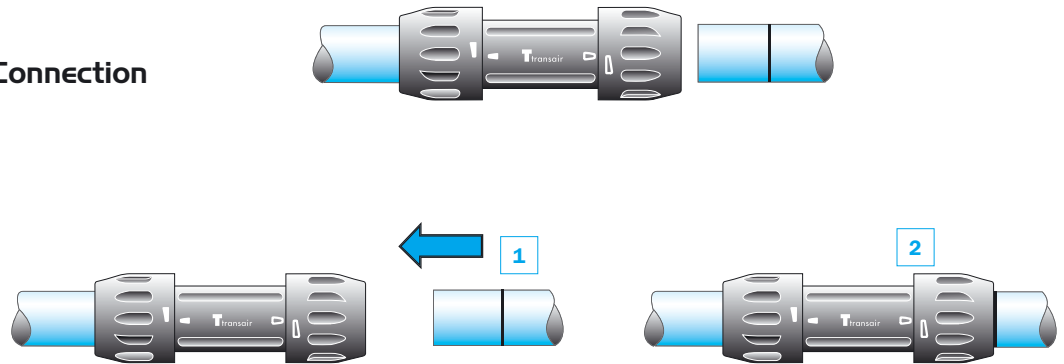

Disconnection

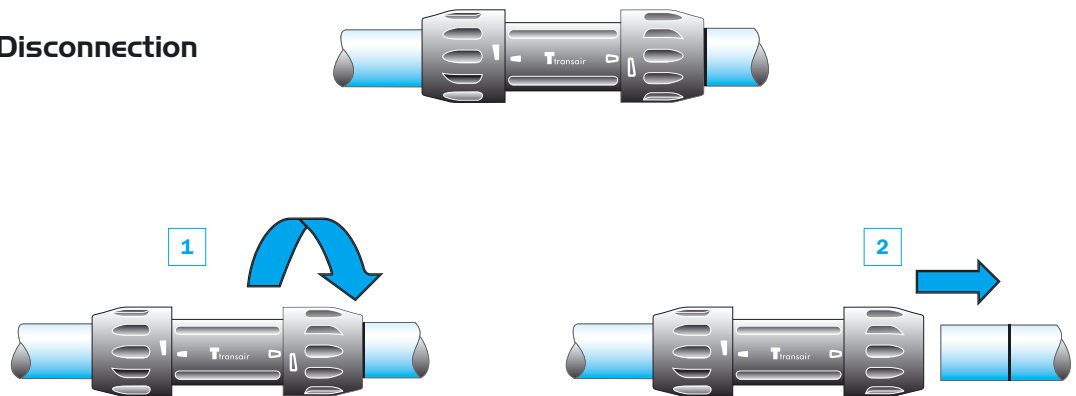

> Ø 16.5
Ø 25
Ø 40

Simply insert the pipe into the connector up to the connection mark.
To disconnect, unscrew the nut by one half turn and remove the pipe.

Lateral dismantling: see page 55 of this guide.

> **Note – when using end caps (ref. 6625)**

The insertion length is greater for end caps than for other Transair connectors. The connection mark should be applied to the pipe by means of a marker and tape measure, using the following values:

- Ø 16.5: 39 mm
- Ø 25: 42 mm
- Ø 40: 64 mm

> Ø 63

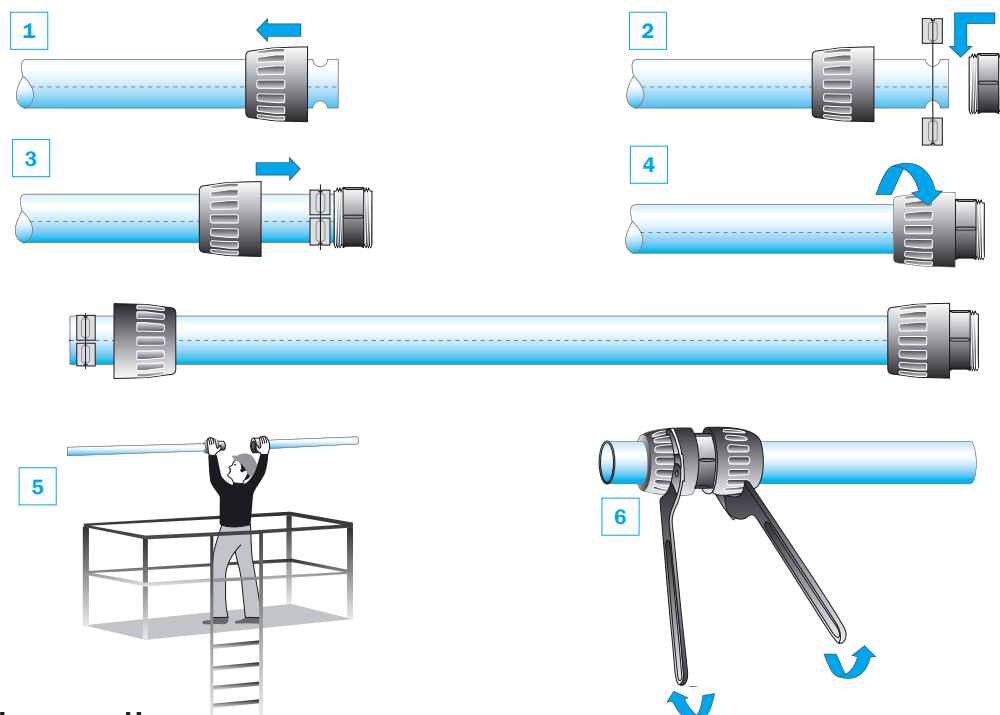
Connection**Disconnection**

- 1 - Unscrew one of the connector nuts and fit over the pipe
- 2 - Position the double clamp ring in the appropriate housings (two holes at the end of the pipe)
- 3 - Bring the nut towards the body, which were previously positioned at the end of the pipe, until it stops against the double clamp

- 4 - Tighten the nut by hand
- 5 - Bring the two pipes together
- 6 - Complete the assembly by 1/2 rotation with Transair tightening spanners ref. 6698 05 03
- 7 - To disconnect, perform the same operations in reverse order

Lateral dismantling: see page 55 of this guide.

> Transair connectors

> Connection / Disconnection

> Ø 76
Ø 100

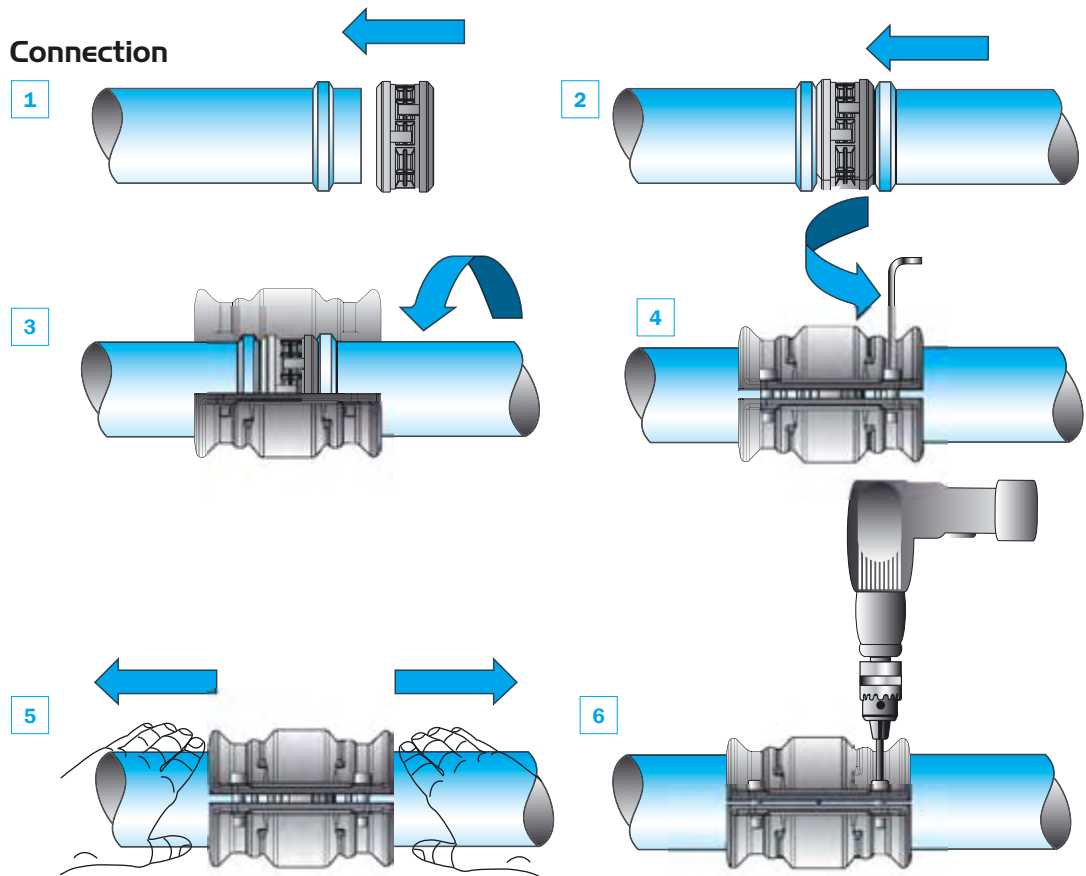

- 1 - Slip the cartridge over the end of the first pipe fully up to the shoulder
- 2 - Bring the second pipe to the cartridge and slide fully up to the shoulder
- 3 - Position the clamp over the cartridge / pipe assembly

- 4 - Hand tighten the pre-fitted screws with an Allen key
- 5 - Pull the pipes fully back towards the outside of the clamp
- 6 - Fully tighten the clamp screws (maximum tightening torque: final closure of clamps)

For effective clamp sealing, screw tightening should be performed on alternate sides of the clamp as shown below:

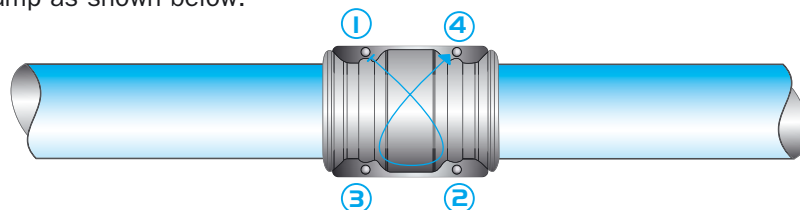

To disconnect, perform the same operations in reverse order.

> Practical examples

> Various Ø 76 and Ø 100 configurations

<p>> Changing direction with a 90° elbow</p>	<p>1 x RX02 + 2 x RR01</p>
<p>> Changing direction with a tee piece</p>	<p>1 x RX04 + 3 x RR01</p>
<p>> Connecting an end cap</p>	<p>1 x RX25 + 1 x RR01</p>
<p>> Connecting a circular flange and a connector</p>	<p>1 x EW05 + 1 x EW06 + 1 x RX30 + 1 x RR01</p>
<p>> Reduction from Ø 100 to Ø 76</p>	<p>1 x RR01 L3 00 + 1 x RX66 L3 L1 + 1 x RR01 L1 00</p>
<p>> Connecting a butterfly valve</p>	<p>1 x RR01 + 1 x RX30 + 1 x VR02 + 1 x RX30 + 1 x RR01</p>
<p>> Connecting a flexible hose and a circular flange</p>	<p>1 x EW05 + 1 x RX30 + 1 x EW06 + 1 x RR01 + 1 x FP01</p>

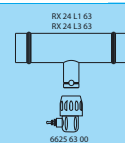
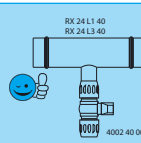
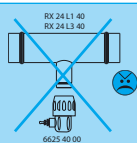

> Transair connectors

> Practical examples

> Connecting a Transair Ø 76 or Ø 100 system to a Transair Ø 63, Ø 40, Ø 25 or Ø 16.5 system

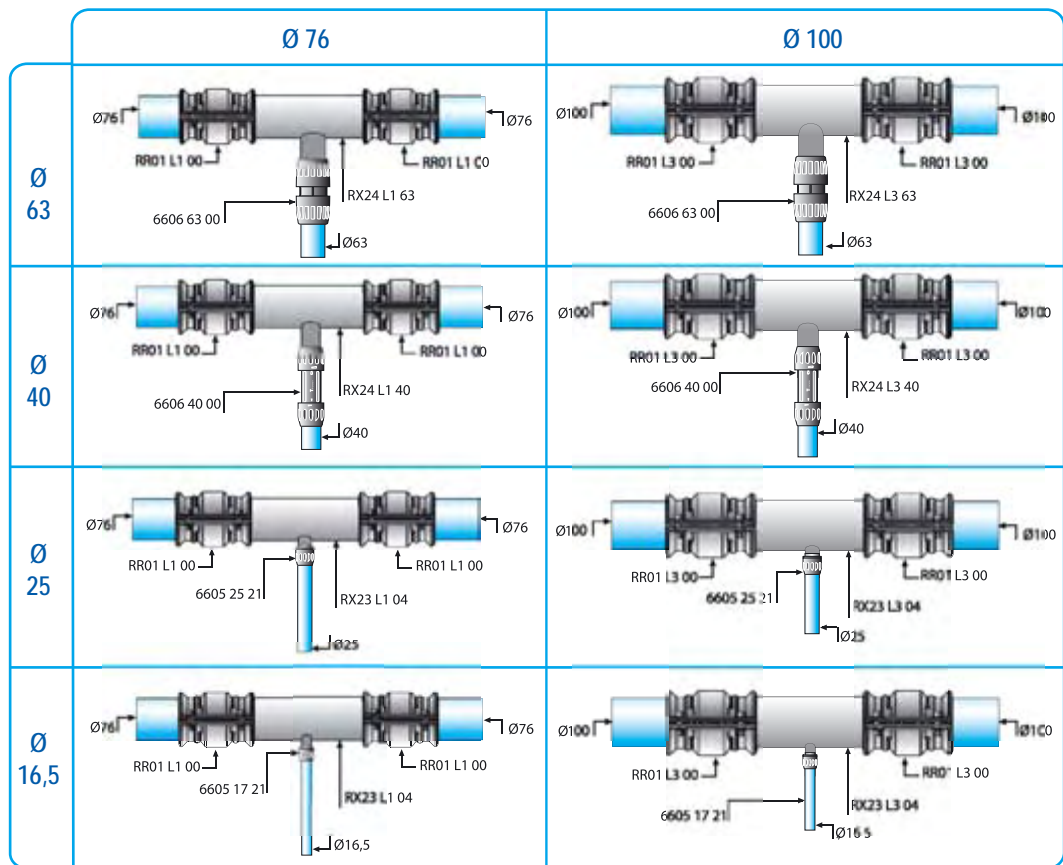

Minimum pipe center-to-center mounting distances for Ø 76 and Ø 100 tees

ØD1(mm)	ØD2(mm)	A(mm)	Bmini(mm)
100	100	90	470
100	76	80	410
100	63	90	327
100	40	46	225
100	25	46	215
100	16,5	46	200
76	76	80	420
76	63	90	314
76	40	46	212
76	25	46	202
76	16,5	46	187

Minimum pipe center to center mounting distances for Ø 76 and Ø 100 brackets

ØD1(mm)	ØD2(mm)	A(mm)	Bmini(mm)
100	25	46	250
76	25	46	240

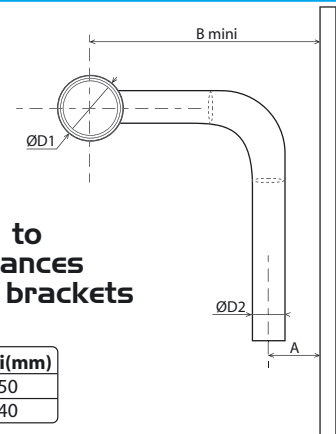

> Lateral dismantling

> Ø 16.5
Ø 25
Ø 40

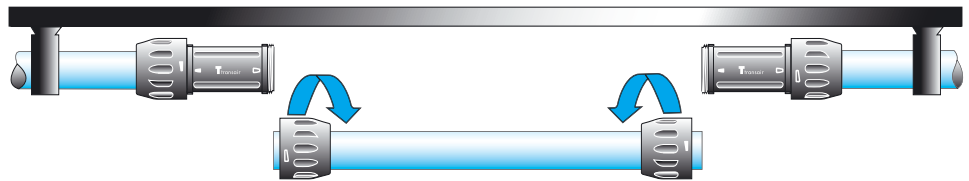

Loosen the nuts located on the side of the pipe to be removed and slide them along the pipe. Then remove the pipe.

> Ø 63

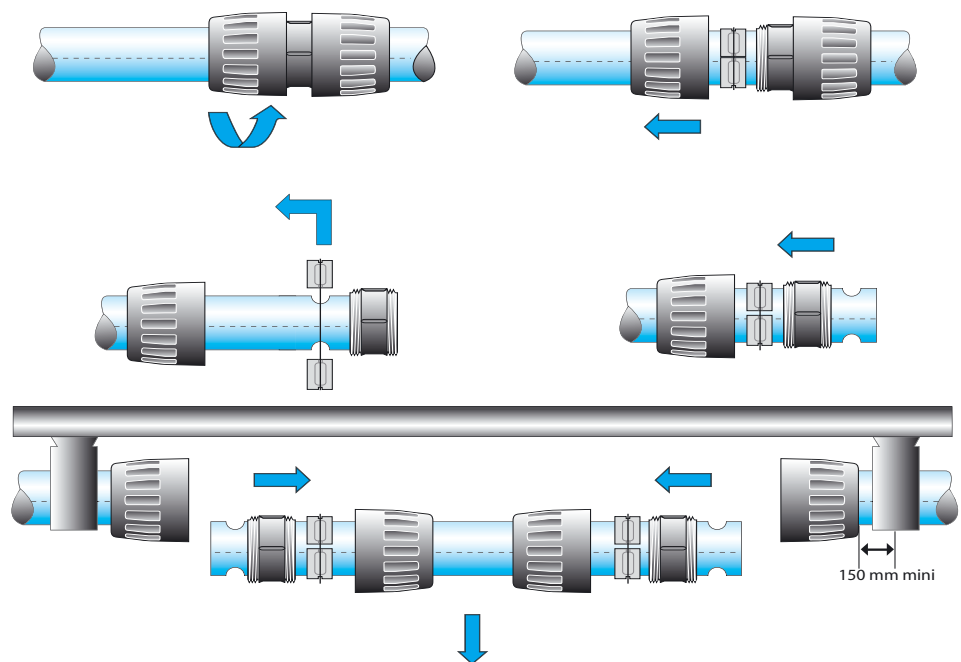

- 1 - Loosen the connector nuts on the ends of the pipe to be removed
- 2 - Slide them along the pipe
- 3 - Remove the clamp rings from their housings

- 4 - Slide the clamps and the connector body along the pipe which is to be removed
- 5 - Repeat the operation at the other end of the pipe and laterally remove the pipe, complete with the assembly components

> Transair connectors

> Practical examples

> Transair Ø 40 remote shut-off valve

> Application

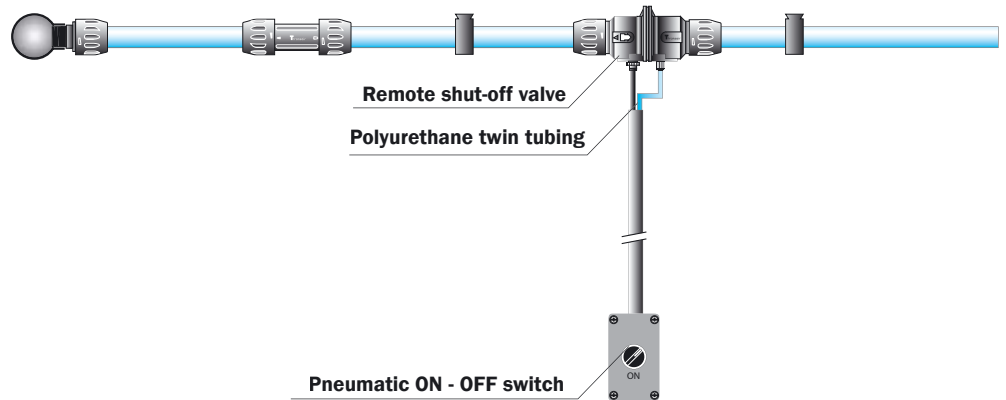

The Transair Ø 40 remote shut-off valve allows network supply to be rapidly and safely opened and closed either at ground level or by remote control.

The Transair remote shut-off valve guarantees:

- Personal safety, by eliminating all hazards related to working at heights
- Servicing speed, by removing the need for special access equipment (ladder, platform etc)

> Operating principle

Single acting valve - normally closed.

For compressed air networks:

The valve control pressure can be taken upstream of the isolating valve, with no external power supply. Control is performed through the control unit connected to the valve by means of a push-in connector.

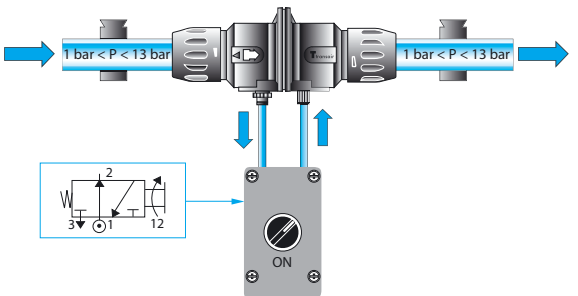

For vacuum networks:

A compressed air supply external to the control unit is required, and the corresponding valve port must be closed in order to prevent loss.

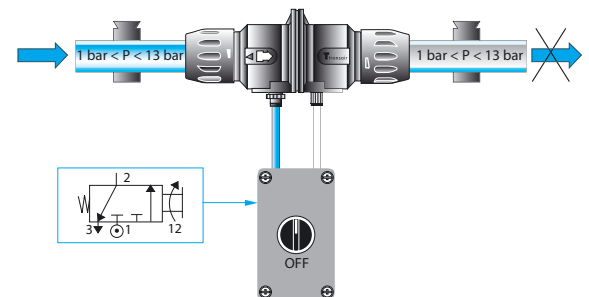

> Do's

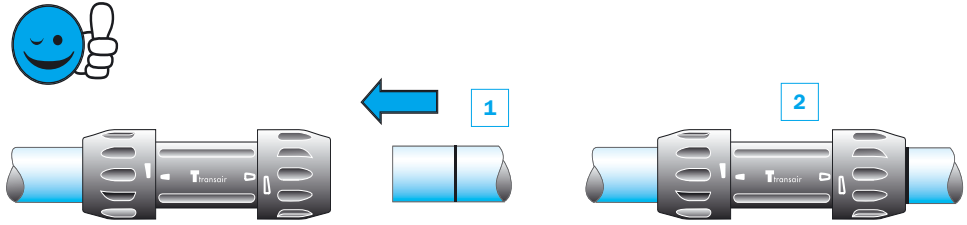
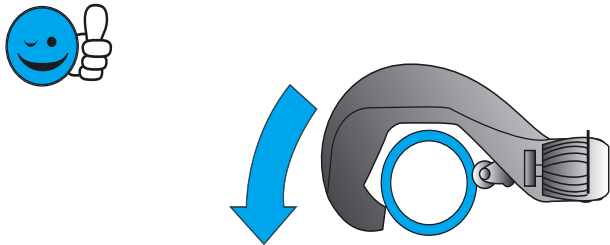
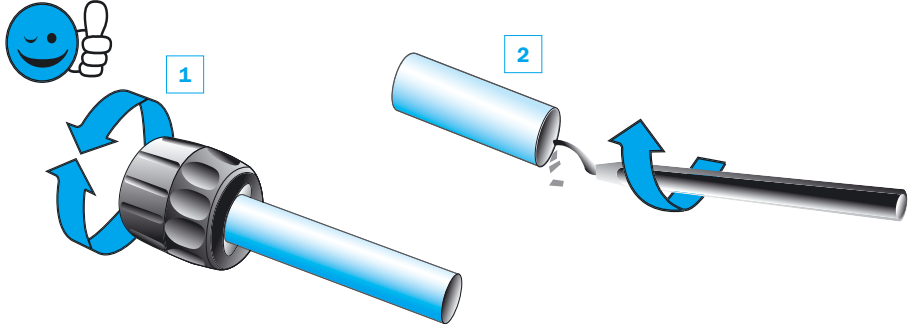
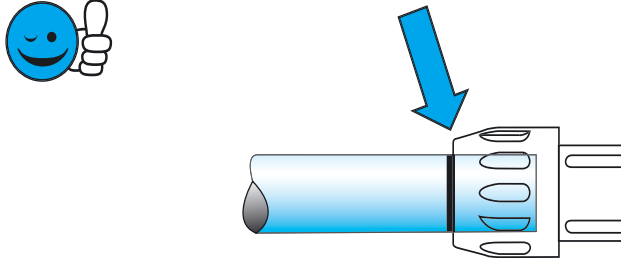
> Connection	
> Use a pipe cutter	
> Carefully chamfer and deburr the pipe after cutting or drilling	
> Check that the pipe is correctly positioned in the connector	

> Transair connectors

> Don'ts

> Loosen the nuts during assembly

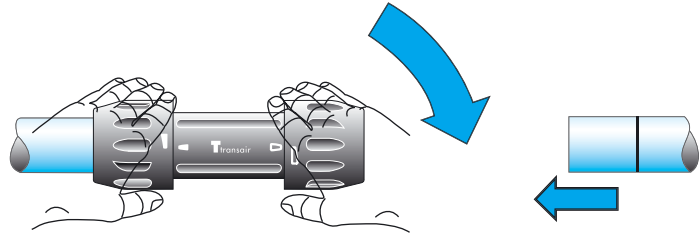

> Cut the pipe with a saw

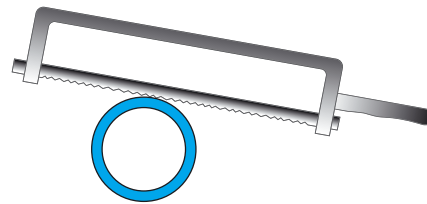

> Use non-deburred pipe

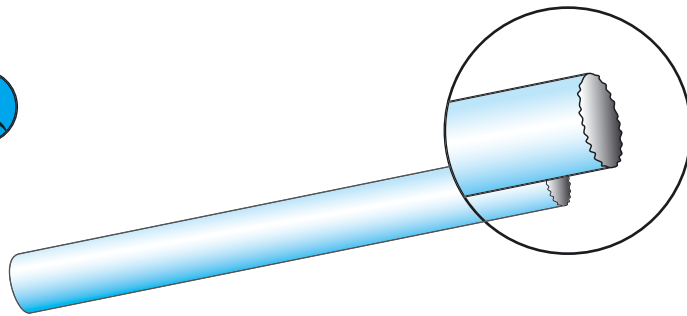

> Fail to make the pipe secure

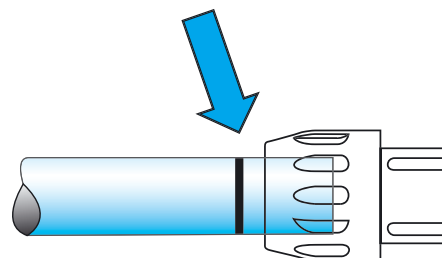

> General

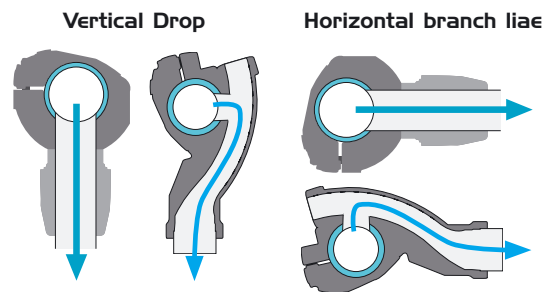

The easy addition of a new drop or bypass onto an existing length of pipe is an important consideration of any air pipe system. Transair quick assembly brackets are designed for this very purpose, without the need to cut the pipe. A "swan neck" built into the brackets retains condensate water in the main line. Thanks to its small size, the Transair quick assembly bracket facilitates new additions in the tightest places and can be used for connecting horizontal branch lines and vertical drops.

> Specific instructions for installing a bracket

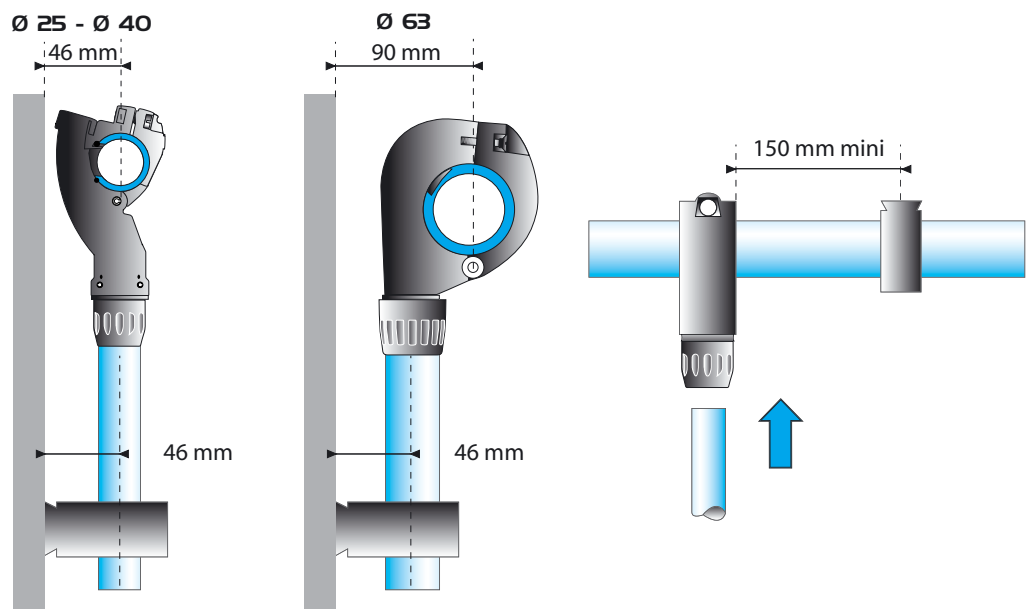

For the Ø 25 and Ø 40 Transair quick assembly brackets, the pipe center to wall distance is equal to the bracket center to wall distance, i.e. 46mm. For the Ø 63 Transair quick assembly brackets, the pipe center to wall distance is 90mm and the Ø 25 and Ø 40 bracket center distance is 46mm. Furthermore, Transair clips should be fitted at a distance of at least 150mm from a quick assembly bracket in order to allow for the expansion / contraction of aluminum pipe.

> Transair quick assembly brackets

> Installing a quick assembly bracket

> To
Ø 25 Ø 40
pipe

> Tools required



Drilling tool for
aluminum pipe
ref. 6698 02 02
or 6698 02 01

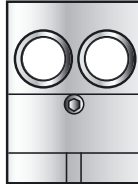

Drilling jig for
aluminum pipe
ref. 6698 01 01



Deburring tool for
aluminum pipe
ref. 6698 04 02



Permanent
marker pen



Allen key
/ Flat end
screwdriver

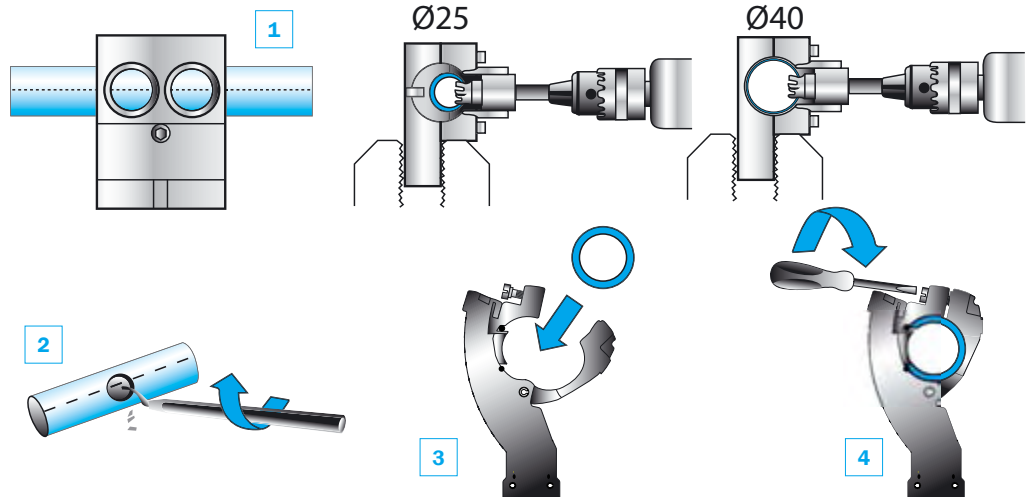

> Procedure

- 1 - Mark the pipe at the desired position for the bracket, using the same locator mark when several take-off points need to be aligned uniformly. Place the drilling jig ref. 6698 01 01 in a vice or on the floor. To drill a Ø 40 hole, remove the retaining bolt in the jig using an Allen key and place the pipe in the jig. The locator mark on the pipe should be aligned with the appropriate guide marks on the side of the jig. Two guide lines on either side of the jig provide a rapid indication of whether the pipe is correctly positioned (the guide lines match the locator marks on the pipe). Close the jig and drill a hole using the appropriate drilling tool:
 - Ø 25: Ø 16 hole > ref. 6698 02 02 drilling tool
 - Ø 40: Ø 22 hole > ref. 6698 02 01 drilling toolRecommended rotation speed: 650 rpm
Note: drill without lubrication.
 - 2 - Release the pipe, remove any chips and deburr the circular hole. Repeat the operation for the number of brackets that you wish to fit.
 - 3 - Position the quick assembly bracket using its location pin
 - 4 - Tighten the screw
- Remark: The jig's second drilling guide corresponds to the minimum distance for fitting two adjacent brackets.

> Installing a bracket

> On Ø 63 pipe

> Tools required



Drilling tool for
aluminum pipe
ref. 6698 02 01

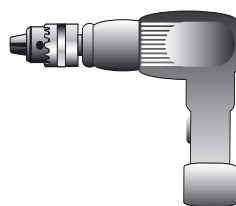

Drill

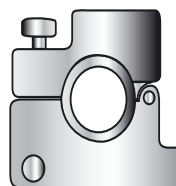

Drilling jig for
aluminum pipe
ref. 6698 01 02



Deburring tool for
aluminum pipe
ref. 6698 04 02



Permanent
marker pen

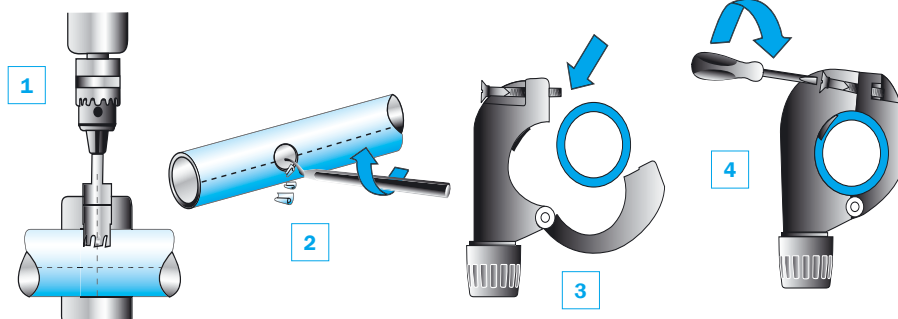

> Procedure

- 1 - Mark the pipe at the desired position for the bracket. The mark should be placed on one of the locator marks so that multiple brackets are correctly aligned, when several take-off points are required. Place the Ø 63 drilling jig in a vice or on the floor and place the pipe in the jig. Ensure that the line marked on the pipe is centred within the drilling guide: two marks on either side of the jig's upper side provide a rapid indication of the pipe's positioning. Tighten the locking clamp to secure the pipe and drill using the Ø 22 drilling tool. [Recommended rotation speed: 650 rpm]
Note: Drill without lubrication.
- 2 - Loosen the locking clamp and release the pipe, remove any chips and deburr the hole. Repeat the operation for the number of brackets that you wish to fit.
- 3 - Position the quick assembly bracket using its location hole
- 4 - Tighten the screw

> Transair quick assembly brackets

> Installing a bracket

> On $\varnothing 76$
 $\varnothing 100$ pipe

> Tools required



Drilling tool for
aluminum pipe,
ref. EW09 00 30



Deburring tool for
aluminum pipe
ref. 6698 04 02

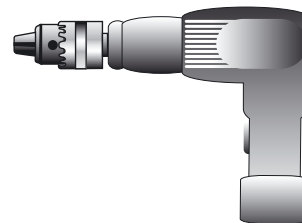

Drill

> Procedure

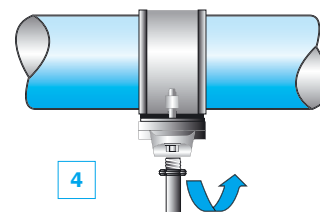
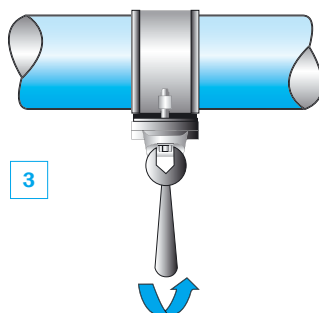
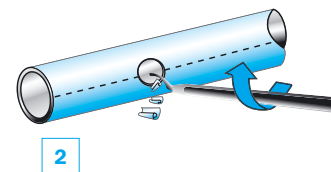
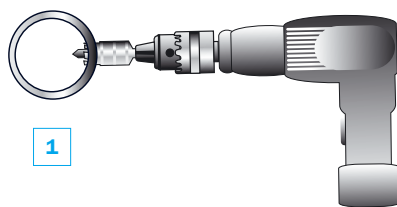

1 - Drill the aluminum pipe at the desired position
using drilling tool ref. EW09 00 30

2 - Carefully deburr the pipe

3 - Position bracket ref. RR61 and fully tighten the
two screws

4 - Screw on male adapter ref. 6621 25 35

Note: Use adapter ref. 6621 25 35 in combination with bracket ref. RR63 to create a $\varnothing 25$ take-off point
from $\varnothing 76$ or $\varnothing 100$ pipe.

> Practical examples

> Creating vertical and horizontal take-off points

Using the same locator mark

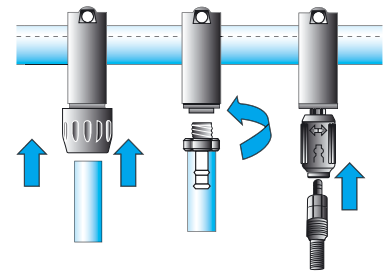
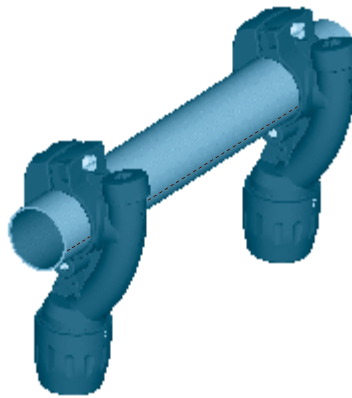

> Adding a vertical bracket

> Adding an off-set bracket

Using two locator marks

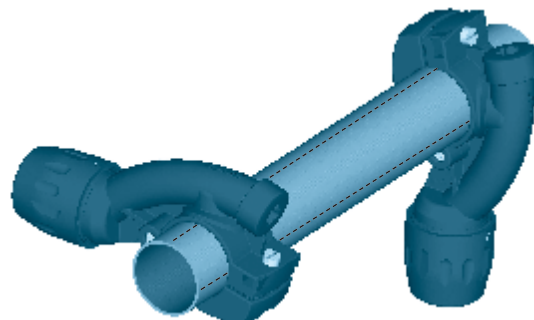
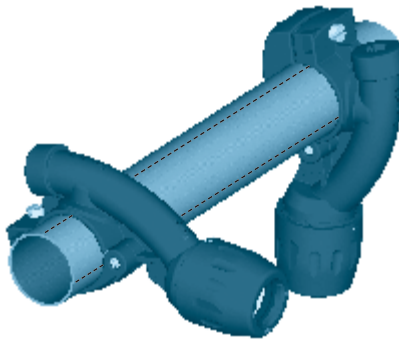

> Transair quick assembly brackets

> Installing a bracket to a pressurised system

> Tools required

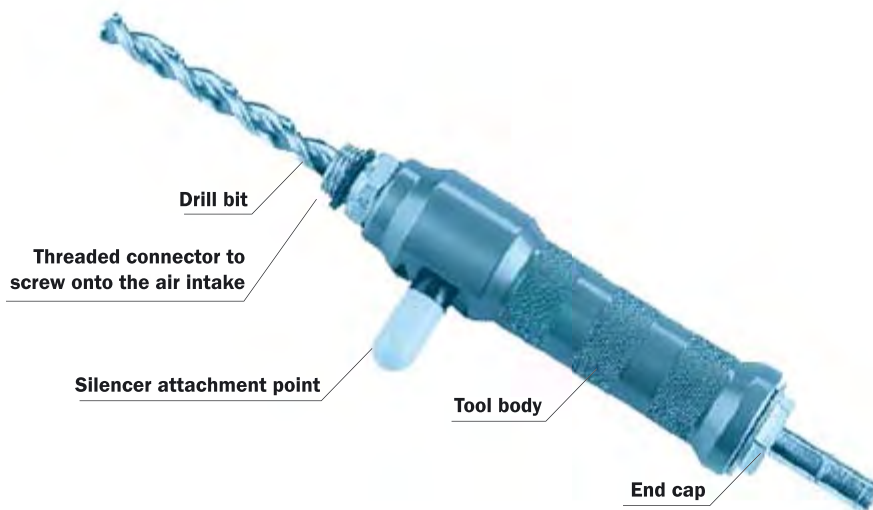

Use the under pressure drilling tool to fit a bracket to an existing pressurised system. This can be simply done with use of a standard drill.

> Procedure

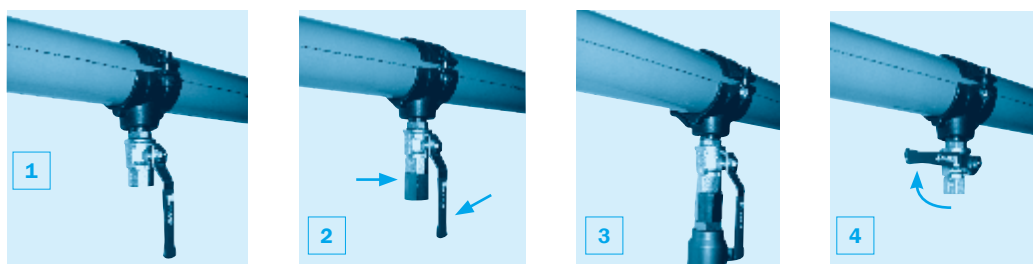

1 - Position the pressurized system bracket and fully tighten the two screws

2 - Screw the assembly onto the ball valve and ensure that the valve is open

3 - Screw the drilling tool onto the ball valve until complete

4 - Remove the drill and close the ball valve immediately and dismantle the drilling tool

> General

> Applications

Transair flexible hose can be easily connected to other Transair components and can be rapidly installed without prior preparation or cutting. Thanks to its small bend radius, it requires minimum space and avoids mechanical stress within the system. Transair flexible hose is resistant to both compressor oils and to fire.

Ø (mm)	Length (in)	Transair	Rmini (in)
25	22	1001E25 00 01	4
25	59	1001E25 00 03	4
25	79	1001E25 00 04	4
25	22	1001E25V00 01	3
25	59	1001E25V00 03	3
25	79	1001E25V00 04	3
40	45	1001E40 00 02	16
40	79	1001E40 00 04	16
40	118	1001E40 00 05	16
40	37	1001E40V00 07	6
40	79	1001E40V00 04	6
40	118	1001E40V00 05	6
63	55	1001E63 00 08	12
63	118	1001E63 00 05	26
63	157	1001E63 00 06	26
63	118	1001E63V00 05	10
63	157	1001E63V00 06	10
76	59	FP01 L1 01	14
76	79	FP01 L1 02	14
100	79	FP01 L3 01	18
100	118	FP01 L3 03	18

> Level change

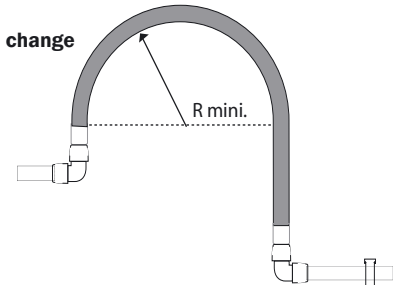

> Obstacle bypass



> Expansion loop

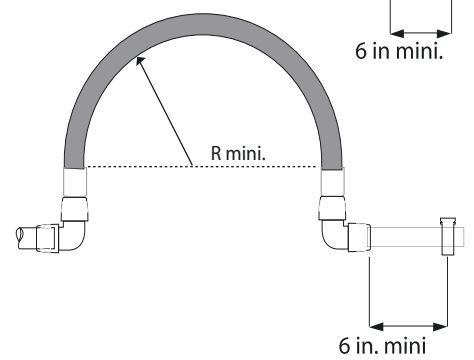

> Safety

> Anti-whiplash straps

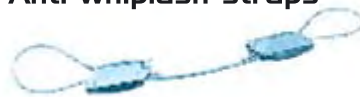

In order to avoid the risk of whiplash accidents, Transair recommends the use of anti-whiplash straps, which are placed on either side of the connection. If Transair flexible tube is exposed to tear, the anti-whiplash assembly prevents it from snaking (safety device in accordance with ISO 4414 standard).

> Transair flexible hose

> System connection

> Ø 16.5
Ø 25
Ø 40

> Using a male threaded fitting

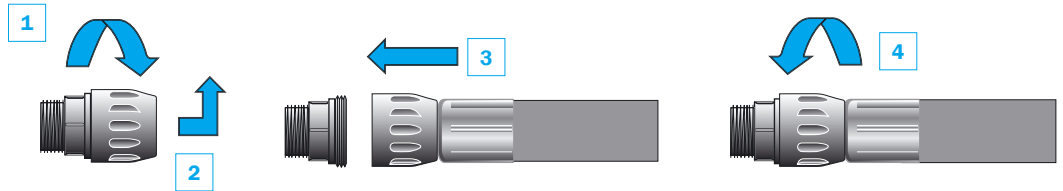

1 - Loosen the nut on the stud fitting
2 - Remove it

3 - Move the swaged end of the hose onto the exposed stud thread
4 - Tighten the nut

> Using a pipe to pipe connector

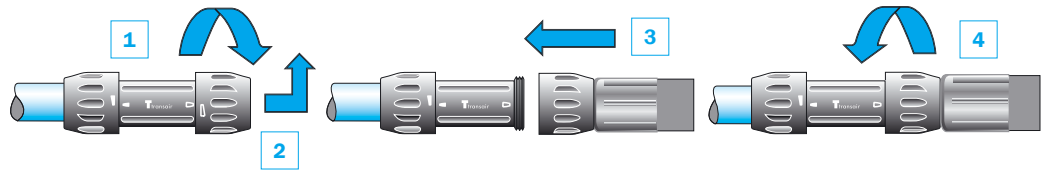

1 - Loosen the nut on the connector
2 - Remove it

3 - Move the swaged end of the hose onto the connector thread
4 - Tighten the nut

> Using a 90° elbow

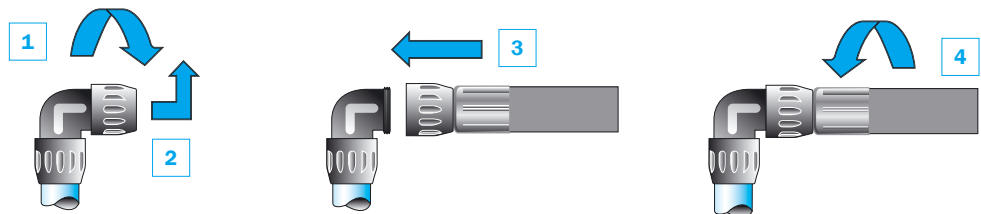

1 - Loosen the nut on the elbow
2 - Remove it

3 - Move the swaged end of the hose onto towards the elbow thread
4 - Tighten the nut

> Ø 63

> Using a male threaded fitting

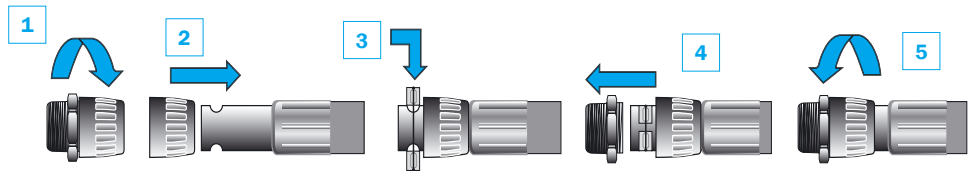

- 1 - Loosen the nut on the stud fitting and remove it
- 2 - Place the nut over the swaged end of the flexible hose
- 3 - Place the pipe connector clamps in the housings on the hose

- 4 - Slide the nut forward to the end of the flexible hose and assemble onto the male thread
- 5 - Tighten the nut using the Ø 63 spanner set

> Using a pipe to pipe connector

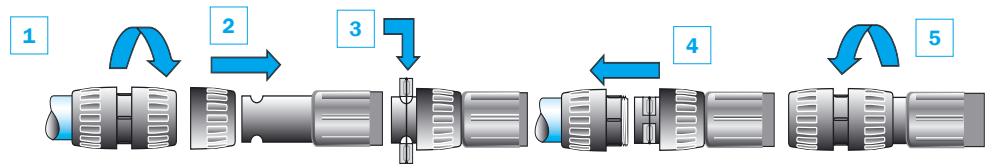

- 1 - Loosen the nut on the connector and remove it
- 2 - Fit it over the swaged end of the flexible hose
- 3 - Place the pipe connector clamps in the housings on the hose

- 4 - Slide the nut forward to the end of the flexible hose, until it touches the clamps
- 5 - Tighten the nut using the Ø 63 spanner set

> Using a 90° elbow

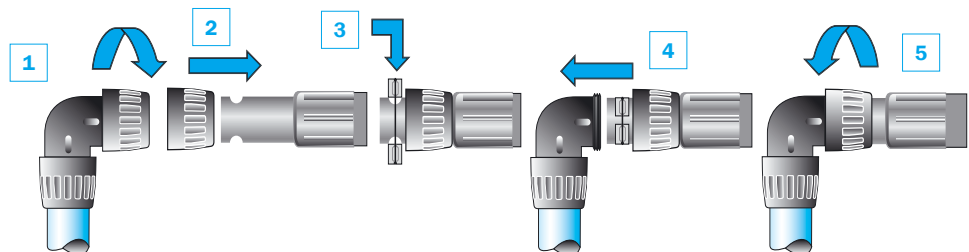

- 1 - Loosen the nut on the elbow and remove it
- 2 - Fit it over the swaged end of the flexible hose
- 3 - Place the elbow clamps in the housings on the hose

- 4 - Slide the nut forward to the end of the flexible hose, until it touches the clamps
- 5 - Tighten the nut using the Ø 63 spanner set

> System connection

> Ø 76 - 100

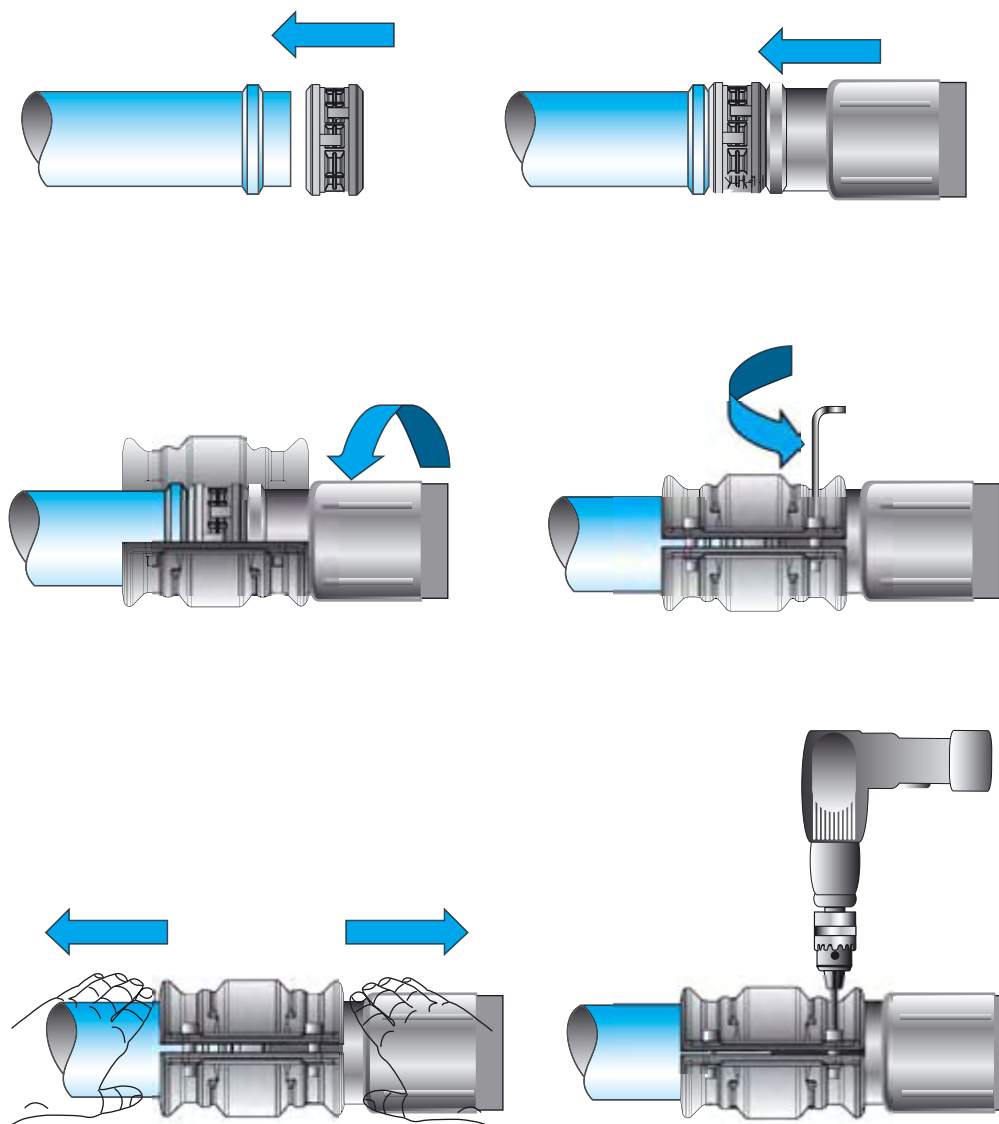

> Using a steel clamp

> Do's / Don'ts

> Do's

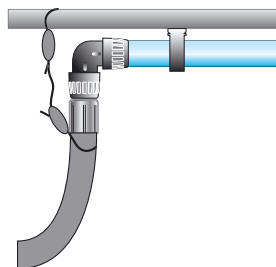
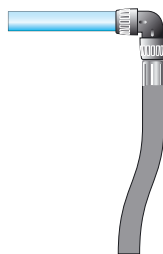
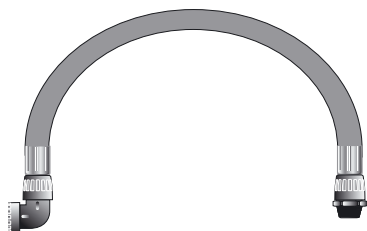
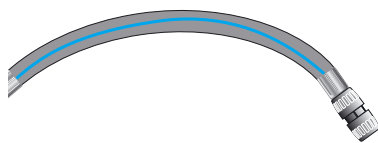
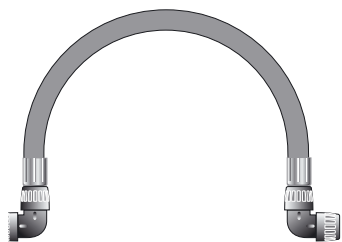
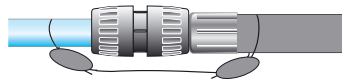

> Don'ts

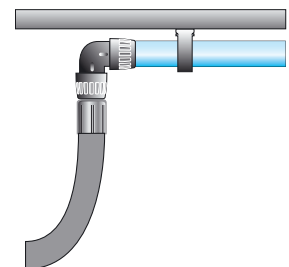
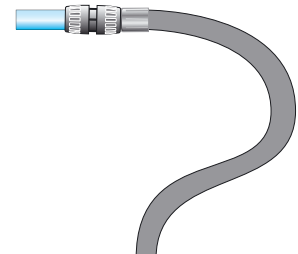
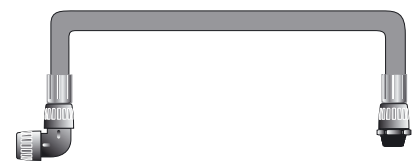
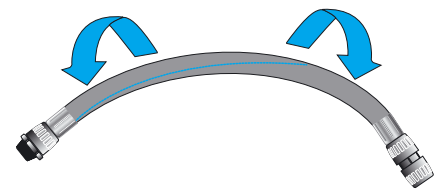
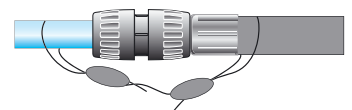

> Fixture accessories

> Transair attachments

> Transair clip for \varnothing 16.5, \varnothing 25, \varnothing 40 and \varnothing 63 rigid pipe

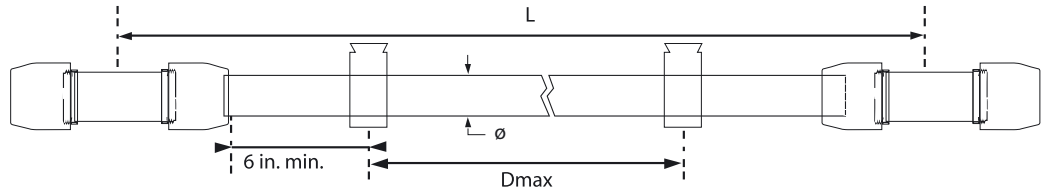

The Transair fixing clip is the basic component for mounting pipe when installing. The \varnothing 16.5 - \varnothing 25 - \varnothing 40 - \varnothing 63 Transair aluminum systems. This clip allows expansion and contraction of the pipe to occur freely.

To ensure good system stability, we recommend the use of at least two clips per pipe. Transair aluminum pipe should only be mounted using Transair and should not be substituted by any other type of clip or fixing.

\varnothing	L (ft)	Dmax (ft)
16.5	10	8
25	10	8
25	20	10
40	10	8
40	20	10
63	20	10

> Properties

- Transair fixing clips for \varnothing 16,5 - \varnothing 25 - \varnothing 40: 1/4" nuts
- Transair fixing clips for \varnothing 63 networks: 3/8" nuts

> Procedure

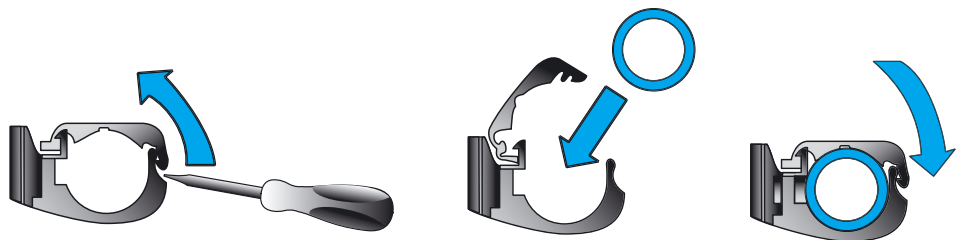

- 1 - Place the clip as required and open it using a screwdriver
- 2 - Insert the pipe into the clip
- 3 - Close the clip

> Spacer

The Transair 6697 00 03 spacer is used for fitting a run of Transair pipe using different diameters.

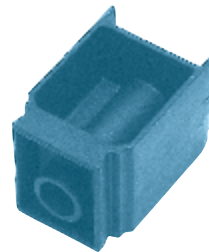

Example:

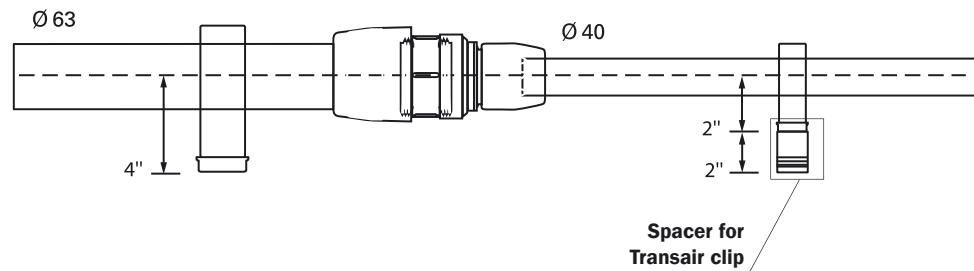

> Transair fixing clips for Ø 76 - Ø 100 systems

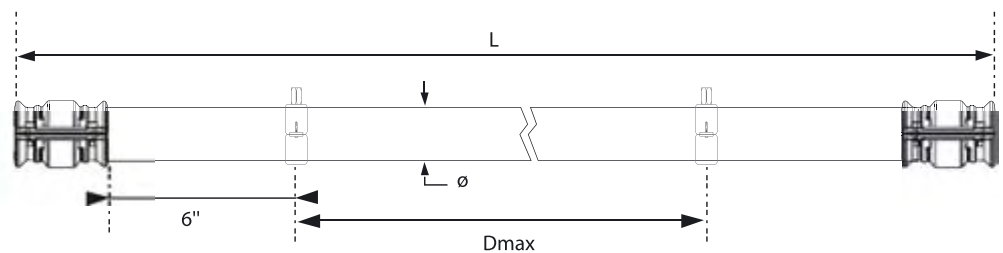

Ø	L (ft)	Dmax (ft)
76	20	16
100	20	16

To ensure good network stability, we recommend the use of at least two fixing clips per length of pipe. Transair fixing clips for Ø 76 and Ø 100 networks: 3/8" thread.

> Fixture accessories

> Supporting a Transair system

> Directly onto a wall

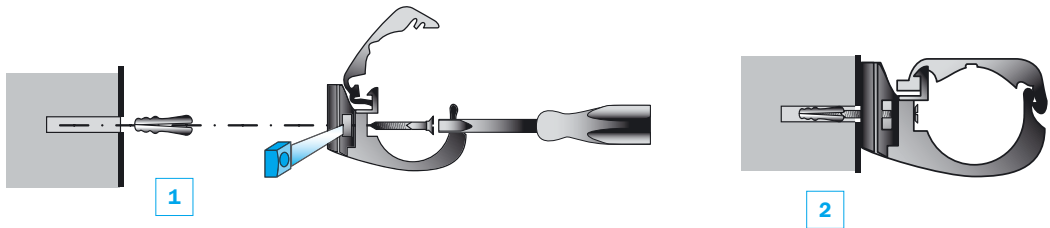

> Offset from a wall

- 1 - Remove the nut at the base of the pipe clip using a screwdriver and insert the screw by passing it through the clip
- 2 - Tighten the screw

> U- channel type mounting bracket

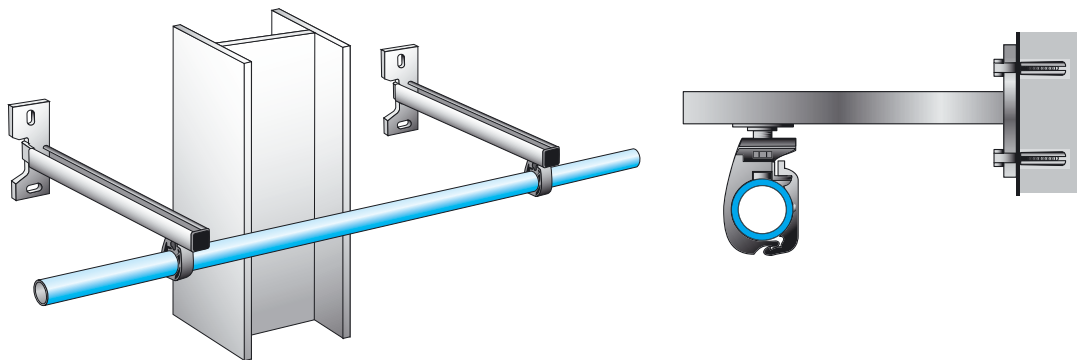

U-channel assemblies are used to offset networks and to bypass obstacles.

> Threaded rod adapter

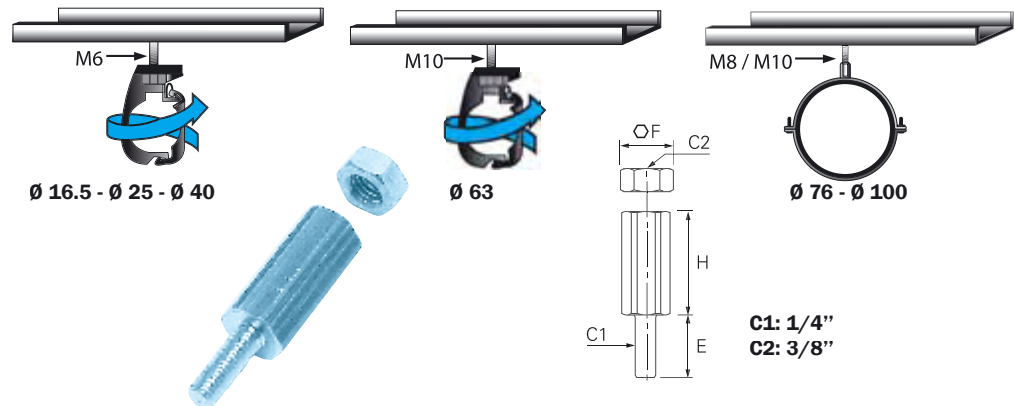

The Transair threaded rod adaptor allows Ø 16.5, Ø 25 and Ø 40 Transair pipe clips to be easily suspended under 3/8" threaded rod.

> On a metal beam

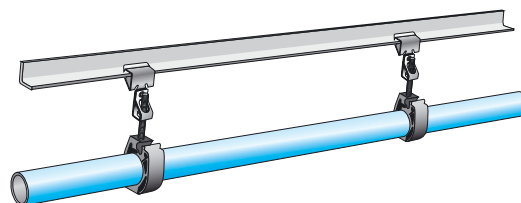

Push-on type beam clamps

> Using beam clamps

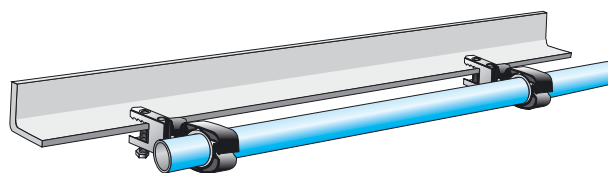

Screw type beam clamps



> Practical information

> Z dimensions

Transair	Z (mm)	Z1 (mm)	Z2 (mm)
4002 40 00	-	57	57
4002 63 00	-	84	98
4089 17 00	-	29	42
4088 25 14	-	40	55
4099 17 00	-	29	42
4099 25 00	-	40	55
4230 00 40	85	-	-
6612 25 00	29	-	-
6612 40 00	45	-	-
6602 17 00	31	-	-
6602 25 00	40	-	-
6602 40 00	62	-	-
6602 63 00	61	-	-
6604 17 00	-	34	31
6604 25 00	-	48	40
6604 40 00	-	57	57
6604 63 00	-	61	61
6604 63 40	-	61	116
6606 17 00	33	-	-
6606 25 00	48	-	-
6606 40 00	57	-	-
6606 63 00	25	-	-
6651 25 12 04	107	-	-
6651 40 12 04	150	-	-
6662 25 00	52	-	-
6662 25 17	59	-	-
6662 40 17	75	-	-
6662 40 25	68	-	-
6662 63 25	75	-	-
6666 17 25	50	-	-
6666 25 40	71	-	-
6676 17 00	33	-	-
6676 25 00	48	-	-
6676 40 00	57	-	-
6676 63 00	25	-	-
RA69 25 17	47.5	-	-
RA69 40 25	61	-	-
RX02 L1 00	189	-	-
RX02 L3 00	221	-	-
RX04 L1 00	-	145	145
RX04 L3 00	-	155	135
RX04 L3 L1	-	155	135
RX23 L1 04	145	-	-
RX23 L3 04	155	-	-
RX24 L1 40	-	145	228
RX24 L1 63	-	145	285
RX24 L3 40	-	155	241
RX24 L3 63	-	155	298
RX64 L1 63	352	-	-
RX64 L3 63	372	-	-
VR02 L1 00	116	-	-
VR02 L3 00	123	-	-

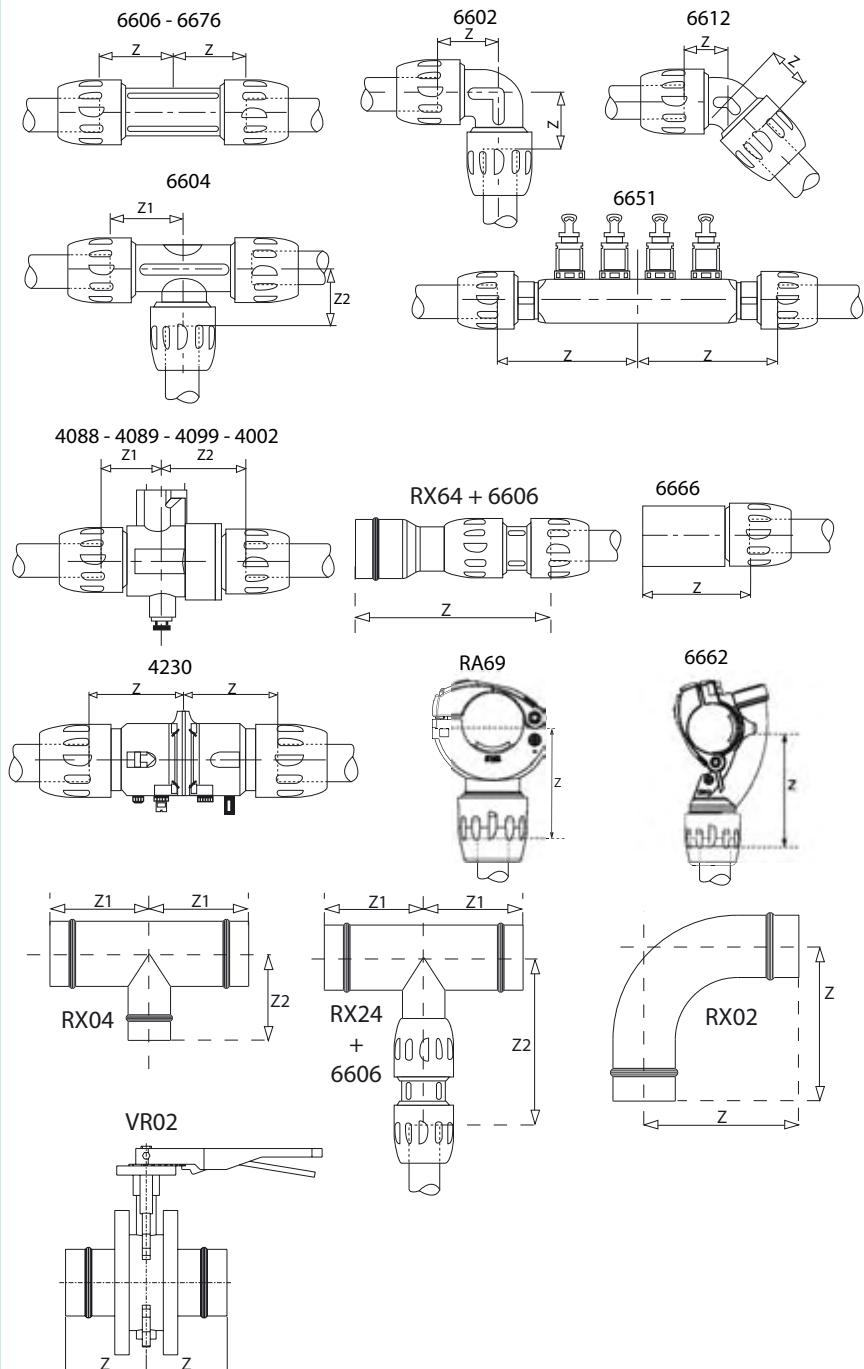

> Expansion / Contraction

In order to compensate for the effects of expansion and contraction due to variations in temperature, any fluctuations in the length of the Transair aluminum pipe network should be calculated.

L: length of Transair straight line to be installed (in m)

ΔT : difference between temperature when installing and maximum operating temperature (in °C)

ΔL : line length variation (in mm)

For Transair \emptyset 16.5 - \emptyset 25 - \emptyset 40 - \emptyset 63 - \emptyset 76 - \emptyset 100 aluminum pipe networks:

$$\Delta L = \frac{(a \times L)}{1} + \frac{(0.024 \times L \times \Delta T)}{2}$$

1 - Expansion related to pipe retraction in the connector

2 - Expansion related to temperature variations

	\emptyset 16.5	\emptyset 25	\emptyset 40	\emptyset 63	\emptyset 76	\emptyset 100
10 ft pipe	a=0.06	a=0.20	a=0.40	a=0.73	a=1.0	a=1.0
20 ft pipe	-	a=0.10	a=0.20	a=0.38	a=0.50	a=0.50

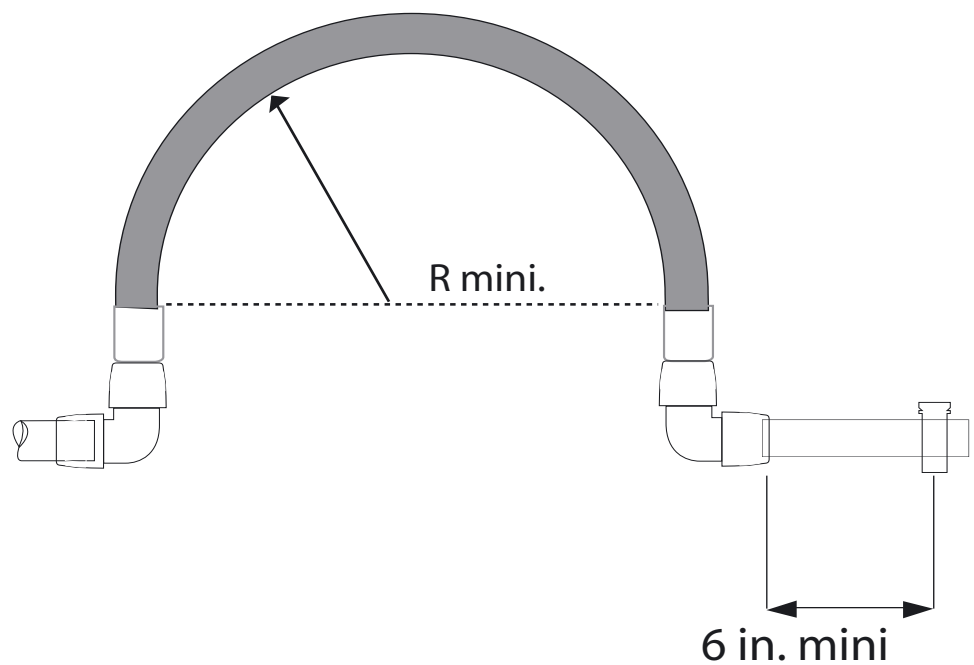

> Practical information

> Expansion / Contraction

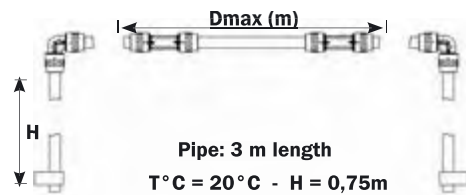

Case no. 1:
Maximum distance, without expansion loop, from a fixed point dependant on Transair diameter (2 elbows)

Ø Transair	16.5	25	40	63	76	100
Dmax. (m)	50	40	30	24	15	15

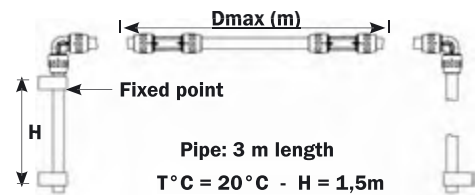

Case no. 2:
Maximum distance, without expansion loop, dependant on Transair diameter (2 elbows - 1 fixed point)

Ø Transair	16.5	25	40	63	76	100
Dmax. (m)	50	40	30	25	15	15

> Example

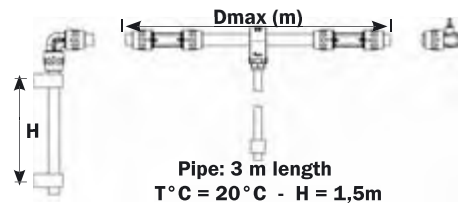

Case no. 3:
Maximum distance for fitting a bracket, without expansion loop, dependant on Transair diameter (1 elbow - 1 bracket)

Ø Transair	16.5	25	40	63	76	100
Dmax. (m)	48	38	30	25	7,5	7,5

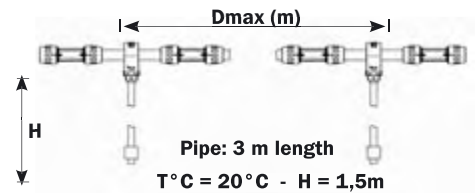

Case no. 4:
Maximum distance for fitting a bracket, without expansion loop, dependant on Transair diameter (2 brackets)

Ø Transair	16.5	25	40	63	76	100
Dmax. (m)	80	70	55	40	15	15

> Direction change

In addition to expansion loops, changes of direction are another method of compensating for expansion and contraction.

> For Transair
 Ø 16.5 - Ø 25 - Ø 40 - Ø 63
 aluminum pipe networks

H= 246'	$\Delta L1= 0.6''$
H= 492'	$\Delta L1= 1.2''$

> For Transair
 Ø 76 -Ø 100
 aluminum pipe networks

H= 246'	$\Delta L1= 3/8''$
H= 492'	$\Delta L1= 6/8''$

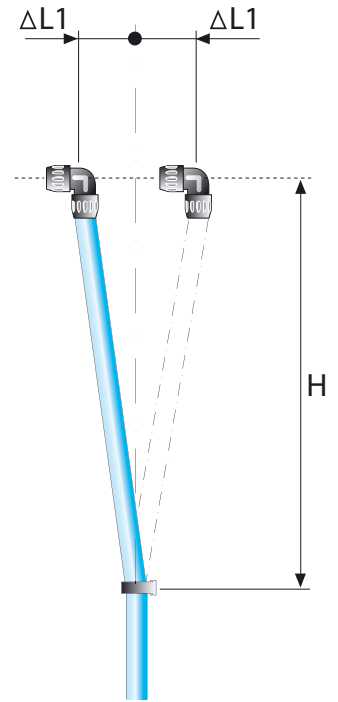

> Using an elbow

> Using a quick assembly bracket

> For Transair Ø 16.5 - Ø 25 - Ø 40 - Ø 63
 aluminum pipe networks

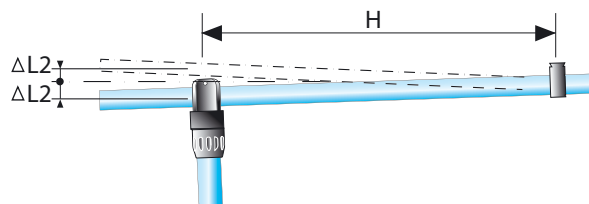

Ø1	Ø2	H (ft)	$\Delta L2$ (in)	$\Delta L3$ (in)
25	16.5	5	1/2	1
25	25	5	1/2	1
40	16.5	5	1/2	1
40	25	5	1/2	1
63	25	5	1/2	1

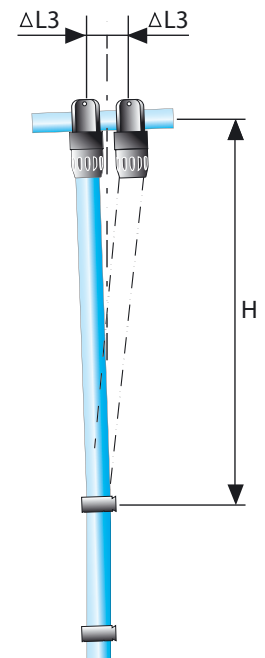

The length variation ΔL , calculated for the Transair line, must always be equal to or less than $\Delta L2$ and $\Delta L3$. If this is not the case, then an expansion loop, using Transair flexible hose, must be added.

> Practical information

> For Transair Ø 76 - Ø 100 aluminum pipe networks

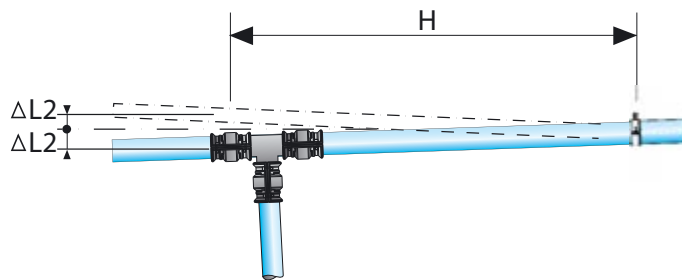

> Changing direction with a tee

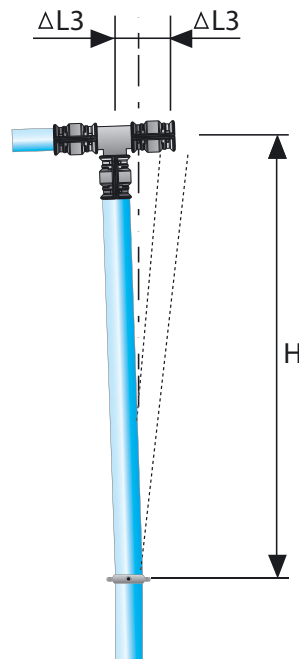

Ø	H (ft)	ΔL2 maxi (in)	ΔL3 maxi (in)
76	2 1/2	3/8	3/8
100	2 1/2	3/8	3/8

> Conversion charts

> Length

millimeter (mm)	meter (m)	inch (in)	foot (ft)	yard (yd)
10	0.01	0.39	0.03	0.01
20	0.02	0.79	0.07	0.02
30	0.03	1.18	0.10	0.03
40	0.04	1.57	0.13	0.04
50	0.05	1.97	0.16	0.05
60	0.06	2.36	0.20	0.07
70	0.07	2.76	0.23	0.08
80	0.08	3.15	0.26	0.09
90	0.09	3.54	0.30	0.10
100	0.10	3.94	0.33	0.11
150	0.15	5.91	0.49	0.16
200	0.20	7.87	0.66	0.22
250	0.25	9.84	0.82	0.27
300	0.30	11.81	0.98	0.33
350	0.35	13.78	1.15	0.38
400	0.40	15.75	1.31	0.44
450	0.45	17.72	1.48	0.49
500	0.50	19.69	1.64	0.55
550	0.55	21.65	1.80	0.60
600	0.60	23.62	1.97	0.65
700	0.70	27.56	2.30	0.76
800	0.80	31.50	2.62	0.87
900	0.90	35.43	2.95	0.98
1 000	1.00	39.37	3.28	1.09

> Pressure

Bar	Kilo Pascal (KPa)	Atmosphere (atm)	PSI	Torr (mm Hg)
1	100	0.99	14.50	750
2	200	1.97	29.00	1 500
3	300	2.96	43.50	2 250
4	400	3.95	58.00	3 000
5	500	4.93	72.50	3 750
6	600	5.92	87.00	4 500
7	700	6.91	101.50	5 250
8	800	7.90	116.00	6 000
9	900	8.88	130.50	6 750
10	1000	9.87	145.00	7 500
11	1100	10.86	159.50	8 250
12	1200	11.84	174.00	9 000
13	1300	12.83	188.50	9 750
14	1400	13.82	203.00	10 500
15	1500	14.80	217.50	11 250
16	1600	15.79	232.00	12 000
20	2000	19.74	290.00	15 000

> Practical information

> Flow rate

liters per second (l/s)	liters per minute (l/min)	cubic meters per minute (m ³ /min)	cubic meters per hour (m ³ /h)	cubic feet per minute (cfm)
10	600	0.60	36	21
20	1 200	1.20	72	42
30	1 800	1.80	108	64
40	2 400	2.40	144	85
50	3 000	3.00	180	106
60	3 600	3.60	216	127
70	4 200	4.20	252	148
80	4 800	4.80	288	169
90	5 400	5.40	324	191
100	6 000	6.00	360	212
150	9 000	9.00	540	318
200	12 000	12.00	720	424
250	15 000	15.00	900	530
300	18 000	18.00	1 080	635
350	21 000	21.00	1 260	741
400	24 000	24.00	1 440	847
450	27 000	27.00	1 620	953
500	30 000	30.00	1 800	1 059
550	33 000	33.00	1 980	1 165
600	36 000	36.00	2 160	1 271
700	42 000	42.00	2 520	1 483
800	48 000	48.00	2 880	1 694
900	54 000	54.00	3 240	1 906
1 000	60 000	60.00	3 600	2 118

> Air consumption values

Tools	Typical CFM consumption at an operating pressure of 87 psi
Small process controls, instrumentation, pneumatic logic units	4
Paint spray gun, small impact wrench, light/medium drill, blowgun	From 5 to 18
Polisher, screwdriver	25
Sheet metal cutter, large impact wrench, automatic plane	28
Small automatic machines, miscellaneous tooling	32
Large tools, power machines and associated equipment	36
Air hoist, grinder	74

**Quality control
department
(Metal Testing Lab)**

Transair Ø 25
Direct drops and offset drops



**Maintenance workshop
(Automotive)**

Transair Ø 25
Offset drops from a quick
assembly bracket



**Production workshop
(Plastics processing)**

Transair Ø 40
Direct drops and offset drops



> Transair system in use

**Main compressed air
pipework system
(Aeronautics)**
Transair Ø 100 and Ø 40



**Outside compressor
room
(Furniture industry)**
Transair Ø 76
90° change of direction



**Compressor room
(Electronics)**
Transair Ø 40 and Ø 16.5



**Assembly workshop
(Mechanics)**

Transair Ø 63 and Ø 25
Offset main network from
U-channel and threaded rod

**Manufacturing cell
(Automotive)**

Transair Ø 76 and Ø 40
Reduction from Ø 76 to Ø 40
Double outlet

**Laboratory
(Chemistry)**

Transair Ø 40
Instant connection



> Transair system in use

Laboratory (Packaging)

Transair Ø 63 and Ø 25
Offset drops from a quick
assembly bracket



Repair workshop (Garage trade)

Transair Ø 25 and Ø 16.5
Wall brackets, FRL and
Transair hose reel



Machinery (Watchmaking)

Transair Ø 25



> Part Numbers Index

Part Number	Pg.	Part Number	Pg.	Part Number	Pg.	Part Number	Pg.	Part Number	Pg.
0169 00 05 00	31	6605 17 14	20	6683 25 22	25	CP05 U1N03	35	RA69 25 17	22
1001E25 00 01	15	6605 17 22	20	6684 17 22	25	CP05 U1N04	35	RA69 40 25	22
1001E25 00 03	15	6605 25 22	20	6684 25 22	25	CP05 U2N02	35	RP01 L1 00	16
1001E25 00 04	15	6605 25 28	20	6687 22 22	25	CP05 U2N03	35	RP01 L3 00	16
1001E25V00 01	15	6605 25 35	20	6688 22 22	25	CP05 U2N04	35	RR01 L1 00	16
1001E25V00 03	15	6605 40 35	20	6697 00 03	32	CP15 A1N02	35	RR01 L3 00	16
1001E25V00 04	15	6605 40 43	20	6697 17 01	32	CP15 A1N03	35	RR21 L1N20	21
1001E40 00 02	15	6605 40 44	20	6697 25 01	32	CP15 A1N04	35	RR21 L1N24	21
1001E40 00 04	15	6605 40 50	20	6697 40 01	32	CP15 U1N02	35	RR63 L1N08	22
1001E40 00 05	15	6605 63 41	20	6697 63 01	32	CP15 U1N03	35	RR63 L3N08	22
1001E40V00 04	15	6605 63 44	20	6698 00 03	28	CP15 U1N04	35	RX02 L1 00	17
1001E40V00 05	15	6605 63 46	20	6698 01 01	28	CP15 U2N02	35	RX02 L3 00	17
1001E40V00 07	15	6606 17 00	16	6698 01 02	28	CP15 U2N03	35	RX04 L1 00	18
1001E63 00 05	15	6606 25 00	16	6698 02 01	29	CP15 U2N04	35	RX04 L3 00	18
1001E63 00 06	15	6606 40 00	16	6698 02 02	29	CP21 A1 06	35	RX12 L1 00	17
1001E63 00 08	15	6606 63 00	16	6698 03 01	28	CP21 A1 08	35	RX12 L3 00	17
1001E63V00 05	15	6612 25 00	17	6698 04 01	29	CP21 A1 10	35	RX20 L1N04	19
1001E63V00 06	15	6612 40 00	17	6698 04 02	29	CP21 U1 06	35	RX20 L3N04	19
1003A17 04 00	14	6621 17 22	21	6698 04 03	30	CP21 U1 08	35	RX24 L1 40	18
1006A25 06 00	14	6621 25 22	21	6698 05 03	30	CP21 U1 10	35	RX24 L1 63	18
1006A40 06 00	14	6621 25 28	21	6698 11 11	34	CP21 U2 08	35	RX24 L3 40	18
1006A63 06	14	6621 25 35	21	6698 11 12	34	CP21 U2 10	35	RX24 L3 63	18
1013A17 04 00	14	6621 40 43	21	6699 01 01	33	CP21 U2 13	35	RX25 L1 00	20
1013A25 04 00	14	6621 40 50	21	6699 01 02	33	EA58 00 14	34	RX25 L3 00	20
1013A40 04 00	14	6625 17 00	20	CA83 A1N02	36	EA98 06 00	24	RX30 L1 00	21
1013A63 04	14	6625 25 00	20	CA83 A1N03	36	EA98 06 00	30	RX30 L3 00	21
1016A25 04 00	14	6625 40 00	20	CA83 U1N02	36	EA98 06 01	24	RX31 L1 00	21
1016A40 04 00	14	6625 63 00	20	CA83 U1N03	36	EA98 06 02	24	RX31 L3 00	21
1016A63 04	14	6651 25 12 04	21	CA83 U2N02	36	EA98 06 03	24	RX64 L1 63	19
4002 40 00	26	6651 40 12 04	21	CA83 U2N03	36	ER01 L1 00	32	RX64 L3 63	19
4002 63 00	26	6662 25 00	23	CA84 A1N02	36	ER01 L3 00	32	RX66 L3 L1	19
4088 25 14	26	6662 25 17	23	CA84 A1N03	36	EW01 00 02	31	TA06 L1 06	14
4089 17 00	26	6662 40 17	23	CA84 U1N02	36	EW02 L1 00	31	TA06 L3 06	14
4099 17 00	26	6662 40 25	23	CA84 U1N03	36	EW02 L3 00	31	TA16 L1 04	14
4099 25 00	26	6662 63 25	23	CA84 U2N02	36	EW03 00 01	31	TA16 L3 04	14
4230 00 40	26	6663 25 22	23	CA84 U2N03	36	EW05 L1 00	21	VR02 L1 00	26
4299 03 01	26	6663 40 22	23	CA94 U1 06	36	EW05 L3 00	21	VR02 L3 00	26
6602 17 00	17	6663 63 22	23	CA94 U1 08	36	EW06 00 01	21		
6602 25 00	17	6663 63 28	23	CA94 U1 10	36	EW08 00 01	28		
6602 40 00	17	6666 17 25	19	CA94 U2 08	36	EW09 00 30	29		
6602 63 00	17	6666 25 40	19	CA94 U2 10	36	FP01 L1 01	15		
6604 17 00	18	6666 40 63	19	CA94 U2 13	36	FP01 L1 02	15		
6604 25 00	18	6676 25 00	16	CP05 A1N02	35	FP01 L3 02	15		
6604 40 00	18	6676 40 00	16	CP05 A1N03	35	FP01 L3 03	15		
6604 63 00	18	6676 63 00	16	CP05 A1N04	35	RA68 25N04	22		
6604 63 40	18	6683 17 22	25	CP05 U1N02	35	RA68 40N04	22		

> Addresses



LEGRIS SA – HEAD OFFICE

BP 70411
35704 RENNES cedex 7
tel: + 33 2 99 25 55 00
fax: + 33 2 99 25 55 99
transair@legris.com

ARGENTINA

Automacion Micromecanica SAIC

Mariano Moreno 6548
1875 Wilde - Buenos Aires
tel: + 54 11 4206 6285
fax: + 54 11 4206 6281
micro@micro.com.ar

AUSTRALIA

Legris Australasia Pty Ltd

Unit 10
8 MC Lachlan Avenue
ARTAMON N.S.W. 2064
tel: + 61 2 943 643 00
fax: + 61 2 943 965 11
Legrisaustralia@legris.com

AUSTRIA

Legris Austria & Eastern Europe

Aredstrasse 29
2544 Leobersdorf
tel: +43 2256 65331
fax +43 2256 65332
legris.cee@legris.com

BELGIUM + LUXEMBOURG

Legris Belgium sa

Chaussée d'Alsemberg 454
1653 Dworp
Tel : 02/333 09 99
Fax : 02/332 11 27
legris.be@legris.com

BRAZIL

Legris do Brasil Ltda

Av. Imperado Pedro II
n.1201-SBC
09770-420 SAO PAULO
tel: + 55 11 4332 9200
fax: + 55 11 4332 5579
legrisbrasil@legris.com.br

CHINA

Legris Wuxi

Fluid Control Systems Co.Ltd
No 50 Chunhui Zhong Road
XiShan Economic Development Zone
Wuxi 214101, JiangsuProv.,P.R. China(CN)
tel: + 86 510 826 5656
fax: + 86 510 826 6922
legrisswx@public1.wx.js.cn

CZECH REPUBLIC

Legris SRO

Brnenska 668
66 442 MODRICE
tel: + 420 547 216 304
fax: + 420 547 216 301
legris@volny.cz

DENMARK

Legris Danmark A/S

Kohavevej 3 B
2950 Vedbæk
tel: + 45 98 204 111
fax: +45 98 204 311
legris.danmark@legris.com

FRANCE

Legris Transair France

74, rue de Paris
35704 Rennes cedex 7
tel: + 33 2 99 25 55 00
fax: + 33 2 99 25 56 47
transairfrance@legris.com

GERMANY

Legris GmbH

Kurhessenstrasse 15
64546 MÖRFELDEN WALLDORF
tel: + 49 6105 910 924
fax: + 49 6105 910 913
info.gmbh@legris.com

HOLLAND

Legris BV

Postbus 74, 1380 AB Weesp
Pampuslaan 112
NL – 1382 JR WEESP
tel: + 31 29 44 80 209
fax: + 31 29 44 80 294
legris.bv@legris.com

HUNGARY

Legris Hungaria

Györfy István u. 1/b
1089 Budapest
HUNGARY
tel: +36 1 30 30 568
fax: +36 1 30 30 568
legris.hungary@legris.com

ICELAND

Sindra Stal hf.

Klettargöroum 12
104 REYKJAVIK
tel: + 354 575 0000
fax: + 354 575 0010
aj@sindri.is

INDIA

Legris India Pvt. Ltd

99, Pace-City-I Sector 37
122001 GURGAON
tel: + 91 124 637 2998
fax: + 91 124 637 2997
legris.india@legris.com

ISRAEL

Ilan and Gavish Automation Service Ltd

26 Shenkar St. Qiryat-arie 49513
P.O. Box 10118-PETACH TIKVA 49001
tel: + 972 3 922 1824
fax: + 972 3 924 0761
ilandg@internet-zahav.net

ITALY

Legris SpA

Via Idiomi, 3/6
20090 ASSAGO (MI)
tel: + 39 02 488613 11
fax: + 39 02 488613 13
legris.italia@legris.com

IVORY COAST

Poly Service Technique

15 BP 450 - ABIDJAN 450
tel: + 225 24 75 17
fax: + 225 24 79 28
pst.ci@aviso.ci

JAPAN

NITTO KOHKI

9-4 Nakaikogami 2-Chome
Ohta-Ku
TOKYO 146-8555
tel: (03) 3755-1111
fax: (03) 3754-4131
kouho@nitto-kohki.co.jp

MOROCCO

AFIT

6-7, rue des Batignolles
21700 CASABLANCA
tel: + 212 22 40 53 44
fax: + 212 22 24 52 54
afit.casa@techno.net.ma

POLAND

Legris Poland

ul. Lubinowa 4a bud. M2
03-878 WARSZAWA
tel: +48 22 678 91 91
fax:+48 22 678 91 91
legris.poland@legris.com

PORTUGAL

Legris, Lda.

Rua Dr. Carlos Silva Mouta, 238
Castelo da Maia
4475-634 SANTA MARIA AVIOSO
Tel: +351 22982 1922
Fax: +351 22982 1924
legris.lda@legris.com

SCANDINAVIA

Legris Scandinavia AB

Box 33
S-230 53 ALNARP
tel: + 46 (0) 40 415700
fax: + 46 (0) 40 532100
legris.scandinavia@legris.com

SINGAPORE

Legris SE Asia Pte Ltd

8 Jalan Kilang Timor 01-04
Kawalram House
159305 SINGAPOUR
tel: + 65 6271 6088
fax: + 65 6274 9978
Legrisea@legris.com

SOUTH AFRICA

Legcon Demcon

P.O. Box 38621
Booyens 2016
JOHANNESBURG
tel: + 27 11 683 8335
fax: + 27 11 683 1080
legcon@cybertrade.co.za

SPAIN

Legris Cenrasa

Pol. Ind. La Ferreria
C/ Alimentacio, 2-4
08110 MONTCADA Y REIXAC
tel: + 34 93 575 06 06
fax: + 34 93 575 38 07
legris.cenrasa@legris.com

SWITZERLAND

Legris AG

J. Renferstrasse 9
2504 Biel/Bienne
tel.: +41 32 344 10 80
fax : +41 32 344 10 70
legris.ch@legris.com

TAIWAN

Legris Taiwan Company Ltd

1&2F, No. 240 Gao Gung Road
TAICHUNG, Taiwan, R.O.C.
tel: + 886 4 226 395 39
fax: + 886 4 226 395 13
legris@legris.com.tw

TURKEY

MERT

Tersane Caddesi 43
Karakoy
ISTANBUL
tel: + 90 212 252 84 35
fax: + 90 212 245 63 69
mertlogistik@turk.net

UNITED KINGDOM

Legris Limited

1210 Lansdowne Court
Gloucester Business Park Hucclecote
GLOUCESTER GL3 4AB
tel: + 44 (0) 1452 623 500
fax: + 44 (0) 1452 623 501
salesuk@legris.com

UNITED STATES OF AMERICA

LATIN AMERICA

Legris Incorporated

7205 E. Hampton Avenue
MESA - AZ 85209
tel: + 1 (480) 830 7764
fax: + 1 (480) 325 3571
transair@legris-usa.com

Legris - Transair

7205 E. Hampton Ave.
Mesa, AZ 85209

Ph. (480) 830-7764

Fax (480) 325-3571

www.transair-usa.com

www.transair-usa.com



A DIVISION OF

GRUPE *LEGRIS* INDUSTRIES

